



Afdichtingssystemen voor balkons, galerijen, loggia's en daken

EXPERTISE
FLOOR COATING





Balkons, loggia's en galerijen behoren door de open bouw tot de zwaarst belaste bouwdelen. Belasting door temperatuur, vochtigheid en intensief zonlicht, maar ook mechanische en chemische belasting, stellen daarom hoge eisen aan het bouwdeel. Maar er is hulp in de vorm van reactieve harscoatings van MC-Bauchemie die jarenlange bescherming en waardebehoud garanderen.

Regelrecht dicht

Bij het uitvoeren van alle afdichtingsmaatregelen moeten altijd de technische bouwvoorschriften in acht genomen worden genomen. Het uitvoeren van afdichtingsmaatregelen is beschreven in DIN 18531 "Afdichting van daken en balkons, loggia's en galerijen".

Europees geregeld

Het gebruik van een vloeibaar aangebracht afdichtingsmateriaal wordt daarentegen gereguleerd door een bouwtoezichtcertificaat (abP) of een Europese technische beoordeling (ETA). Deze documenten worden afgegeven op basis van het Europese beoordelingsdocument EAD 030350000402 (voorheen ETAG 005).

In deze brochure worden diverse coating- en afdichtingsconstructies gepresenteerd die bijdragen aan een betrouwbaar waarde behoud van het vastgoed. De systeemopbouw varieert van een eenvoudig kleurdesign met **MC-DUR TopSpeed** tot een flexibele, duurzame afdichting met **MC-DUR TopSpeed flex plus**.

MC-Dur TopSpeed flex plus is een vloeibaar aan te brengen afdichtingssysteem dat voldoet aan de hoogste eisen volgens Europese specificaties. Deze omvatten bijvoorbeeld een levensduur van 25 jaar (categorie W3) en gebruik in extreme klimaatzones van -30 °C tot +90 °C (**categorieën TL4 & TH4**).

Gedetailleerd werk

Bij het uitvoeren van deze afdichtingsmaatregelen moet speciale aandacht worden besteed aan de gedetailleerde uitvoering van de verbindingen, aan- en afsluitingen voor doordringen, evenals voegvorming.

Hoewel dit niet specifiek onder bouwtoezicht valt, is het essentieel dat dergelijke werkzaamheden met de nodige zorg en professionaliteit worden uitgevoerd om de integriteit van dergelijke verbindingen onder invloed van gebruik en omgevingsfactoren te blijven garanderen. Deze brochure biedt een overzicht van coatingsysteemstructuren voor verschillende toepassingen, samen met de bijbehorende detaillering-informatie voor verbindingen.

MC-DUR TopSpeed – Het veelzijdig toepasbare coating- en afdichtingssysteem

Het bekleden van balkons, loggia's, galerijen en daken stelt bijzondere eisen aan de planning en de uitvoering. Naast nationale en Europese specificaties zijn er nog andere eisen waaraan een geschikt afdichtingssysteem moet voldoen.

Dit zijn bijvoorbeeld snelheid van uitvoering, vochtollerantie, permanente UV- en kleurvastheid, evenals de mogelijkheid om verschillende opbouwsystemen te kunnen realiseren, afhankelijk van het gewenste ontwerp, toepassingsgebied en latere toepassing. De functie van dit systeem varieert van een eenvoudig kleurontwerp tot een duurzaam bestendige waterdichting onder plaatvormige bedekkingen tot de basis voor een duurzaam groendak.

- Verwerking bij 2 °C – 35 °C
- Vochtbestendig tijdens bouw
- Snelle uitharding
- Hoge scheuroverbrugging
- UV-bestendig





Inhoud

Primerlijst	7
Systeemopbouw	8 – 15
Eenvoudig kleurontwerp	10 – 11
Opbouw volgens EAD 030350000402 (voorheen ETAG 005)	12
Opbouw conform DIN 18531	13 – 15
Afdichtingsdetails	16 – 39
01a: Vloer-wand-aansluiting	18
01b: Vloer-wand-aansluiting met tegels	19
02a: Isolatie	20
02b: Isolatie met tegels	21
03a: Stootvoegen	22
03b: Stootvoegen met tegels	23
04a: Randafwerking met goot	24
04b: Randafwerking met goot en tegels	25
05a: Deuraansluiting 5 cm	26
05b: Deuraansluiting 5 cm met tegels	27
06a: Deuraansluiting 15 cm	28
06b: Deuraansluiting 15 cm met tegels	29
07a: Deuraansluiting barrièrevrij	30
07b: Deuraansluiting barrièrevrij met tegels	31
08a: Buisdoorvoer	32
08b: Buisdoorvoer met tegels	33
09a: Geul zonder flens	34
09b: Geul zonder flens met tegels	35
10a: Geul met flens	36
10b: Geul met flens en tegels	37
11a: Relingvoet	38
11b: Relingvoet met tegels	39

Primerlijst



De passende basis voor verschillende ondergronden

Minerale ondergronden en tegels	
Grondering	MC-DUR 1177 WV-A
Schraaplaag	MC-DUR TopSpeed SC / MC-DUR 1320 VK (afstrooien)
Afdichtingslaag	MC-DUR TopSpeed flex plus
Weefsel	MC-Floor Tex
Staal	
Grondering	Colusal Speed Primer / Mycoflex 251
Afdichtingslaag	MC-DUR TopSpeed flex plus
Weefsel	MC-Floor Tex
RVS	
Grondering	Mycoflex 4100 TS
Afdichtingslaag	MC-DUR TopSpeed flex plus
Weefsel	MC-Floor Tex
Naaldhout, hardhout en schuimisolatie	
Grondering	MC-DUR 1177 WV-A
Afdichtingslaag	MC-DUR TopSpeed flex plus
Weefsel	MC-Floor Tex
Hard-PVC en GFK-polyester	
Grondering	Geen grondering noodzakelijk
Afdichtingslaag	MC-DUR TopSpeed flex plus
Weefsel	MC-Floor Tex

Systemopbouw

Systeemopbouw

Gekleurde basisafwerking



Grondering	MC-DUR 1177 WV-A	ca. 300 g/m ²
Schraaplaag	MC-DUR TopSpeed SC + KZ (1:1)	ca. 1.200 g/m ²
Verzegeling	MC-DUR TopSpeed + Glasparels (3 - 5%)	ca. 2 x 250 g/m ²

KZ = Kwartszand

Systeemopbouw

Gekleurde basisafwerking

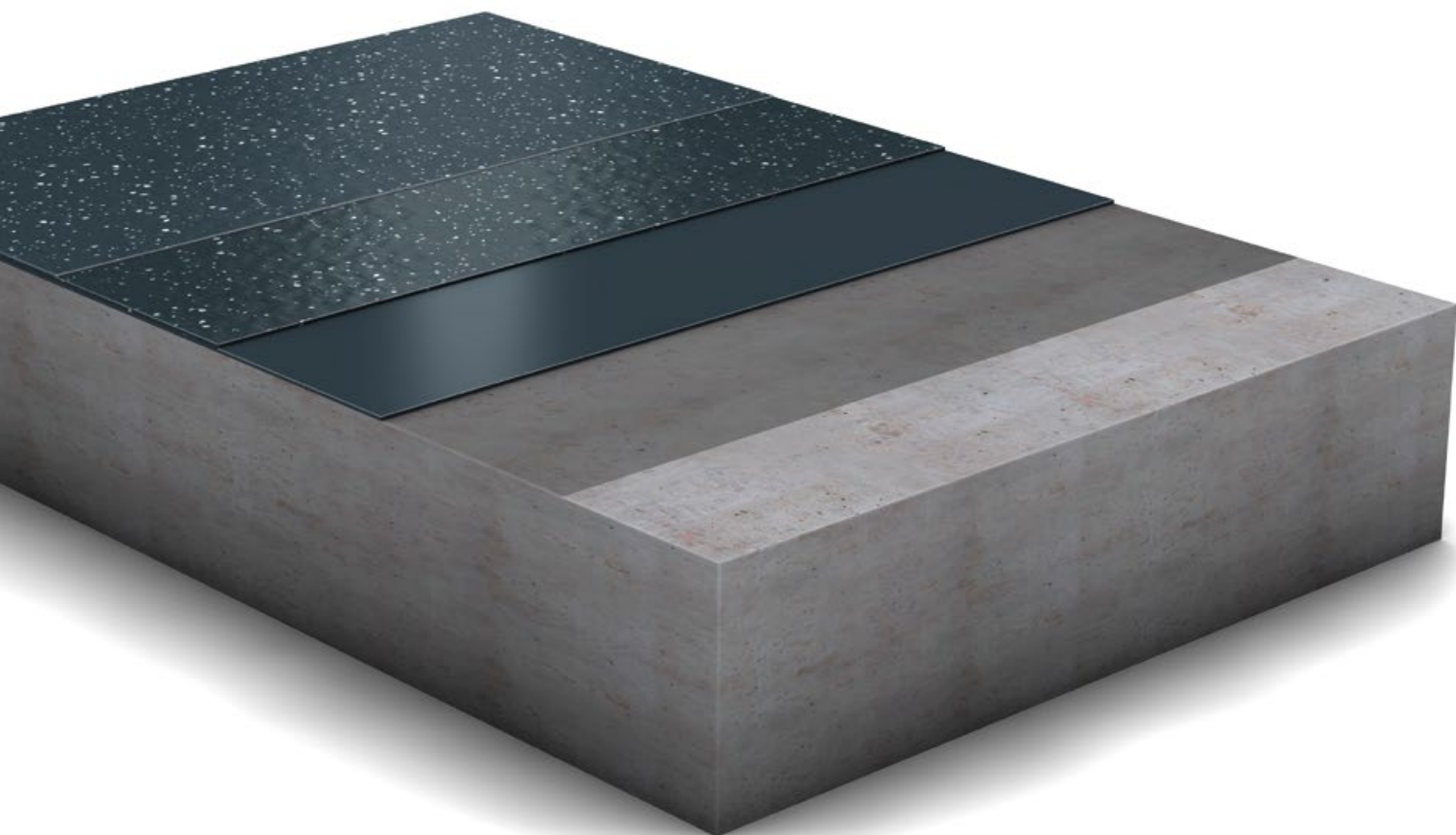

Grondering	MC-DUR 1177 WV-A	ca. 300 g/m ²
Coating	MC-DUR TopSpeed	ca. 2 x 250 g/m ²
Instrooiing	MC-Dekorchips	ca. 30 g/m ²
Verzegeling	MC-DUR TopSpeed M/T	ca. 150 g/m ²

KZ = Kwartszand

Stroomopbouw

Opbouw conform EAD 030350-00-0402

(voorheen ETAG 005)

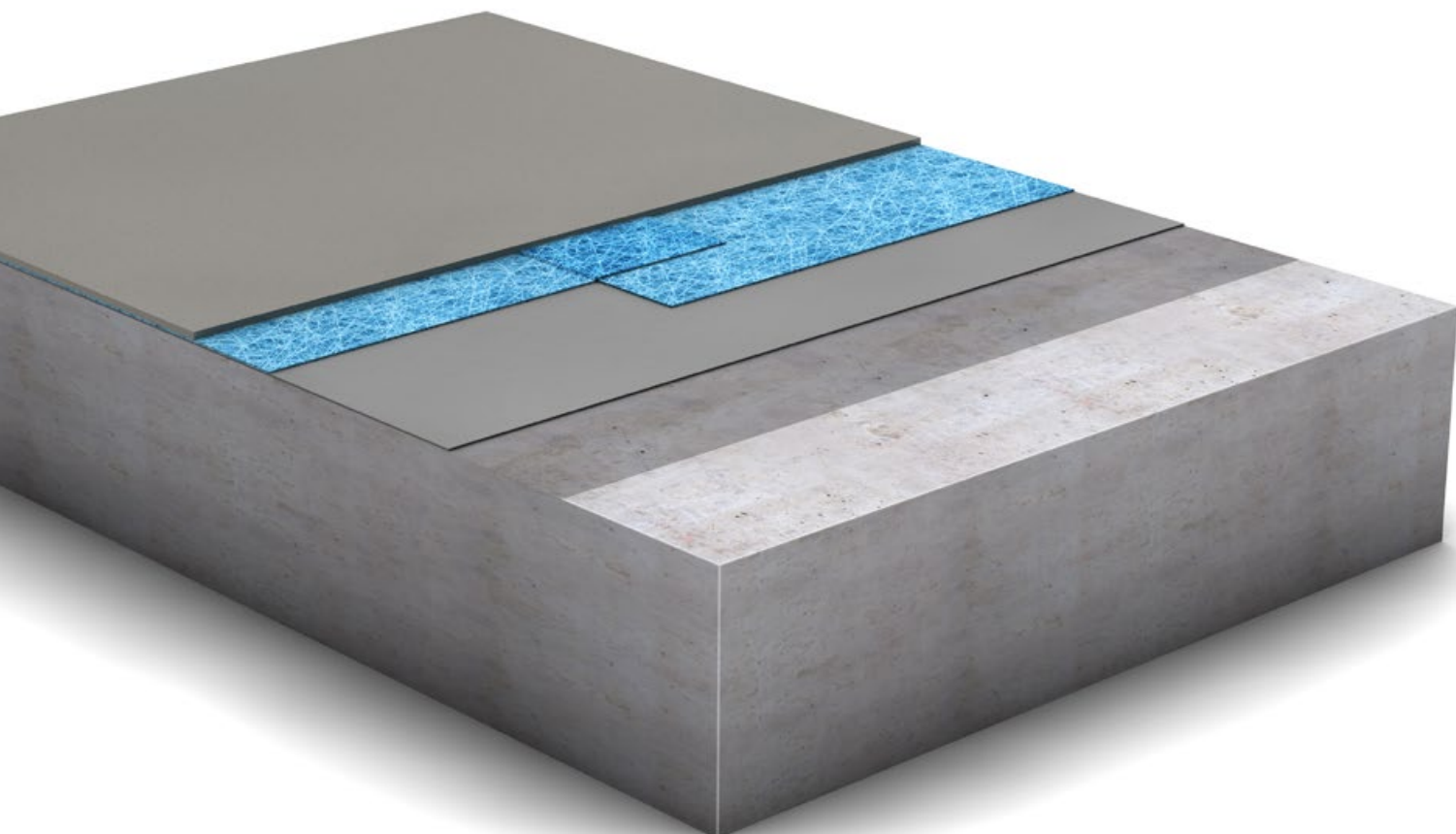

Grondering	MC-DUR 1177 WV-A	ca. 300 g/m ²
Afdichtingslaag	MC-DUR TopSpeed flex plus	ca. 1.250 g/m ²
Weefselvlies	MC-Floor Tex	110 g/m ²
Afdichtingslaag	MC-DUR TopSpeed flex plus	ca. 1.250 g/m ²

KZ = Kwartszand

Stroomopbouw

Opbouw conform with DIN 18531

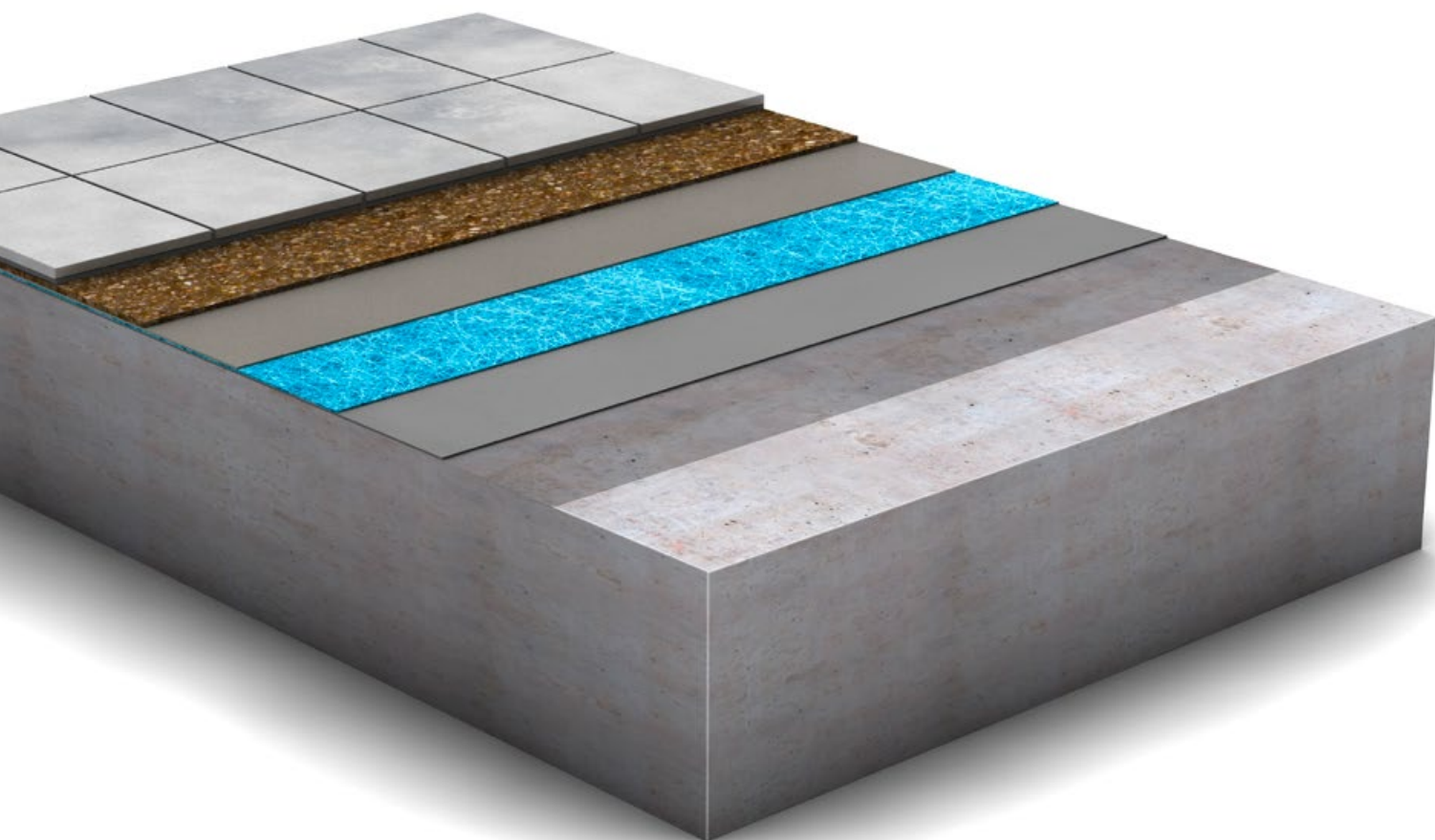

Grondering	MC-DUR 1177 WV-A	ca. 300 g/m ²
Afdichtingslaag	MC-DUR TopSpeed flex plus	ca. 1.250 g/m ²
Weefselvlies	MC-Floor Tex	110 g/m ²
Afdichtingslaag	MC-DUR TopSpeed flex plus	ca. 1.250 g/m ²
Instrooilaag	MC-DUR TopSpeed flex plus + KZ (volzat)	ca. 400 g/m ²

KZ = Kwartszand

Systemopbouw

Opbouw conform with DIN 18531

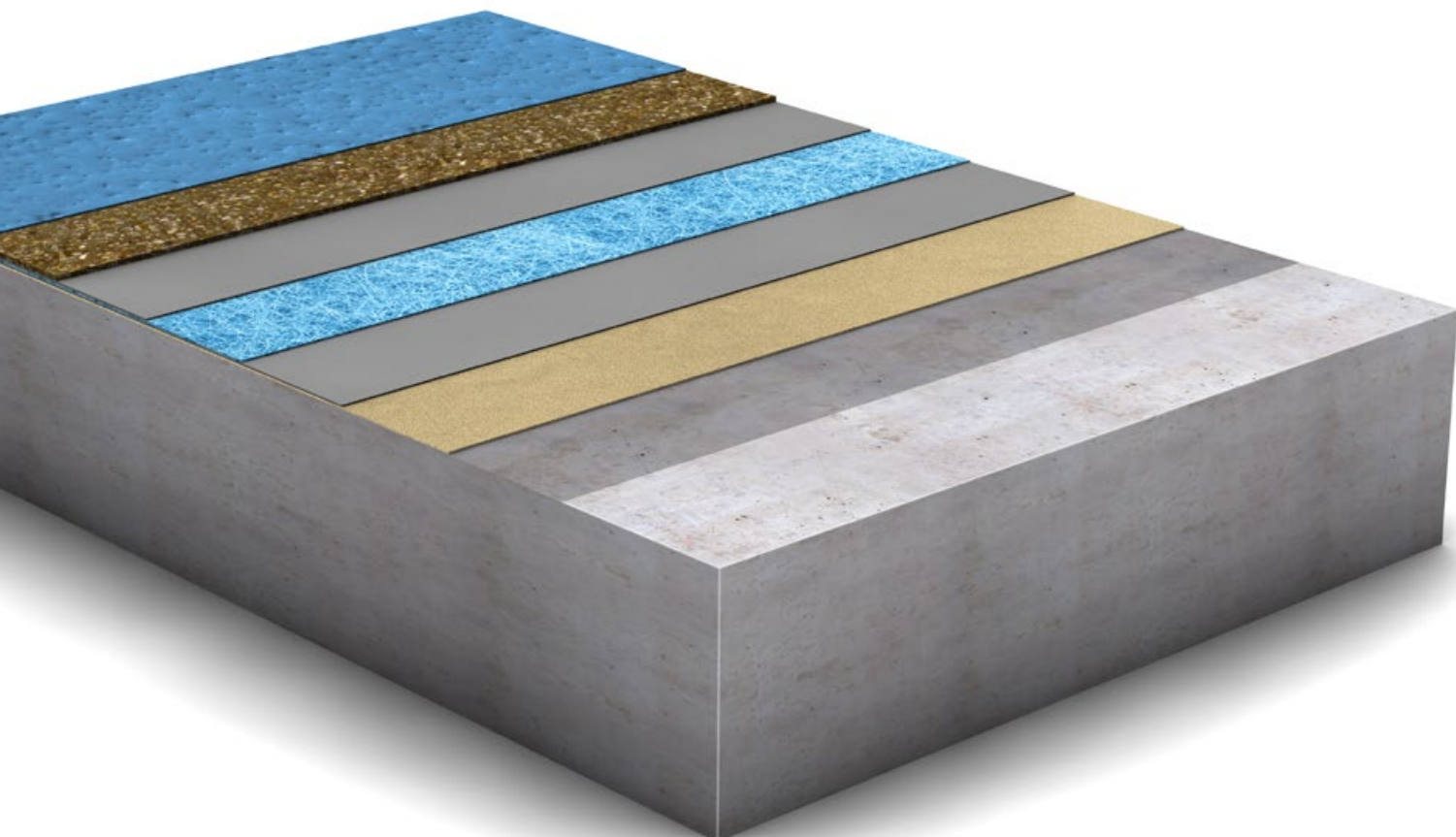

Grondering	MC-DUR 1177 WV-A	ca. 300 g/m ²
Schraaplaag	MC-DUR TopSpeed SC + KZ (1:1)	ca. 1.200 g/m ²
Afdichtingslaag	MC-DUR TopSpeed flex plus	ca. 1.250 g/m ²
Weefselvlies	MC-Floor Tex	110 g/m ²
Afdichtingslaag	MC-DUR TopSpeed flex plus	ca. 1.250 g/m ²
Instrooilaag	MC-DUR TopSpeed + KZ (volzat)	ca. 400 g/m ²
Verzegeling	MC-DUR TopSpeed	ca. 600 g/m ²

KZ = Kwartszand

Stysteemopbouw

Opbouw conform with DIN 18531

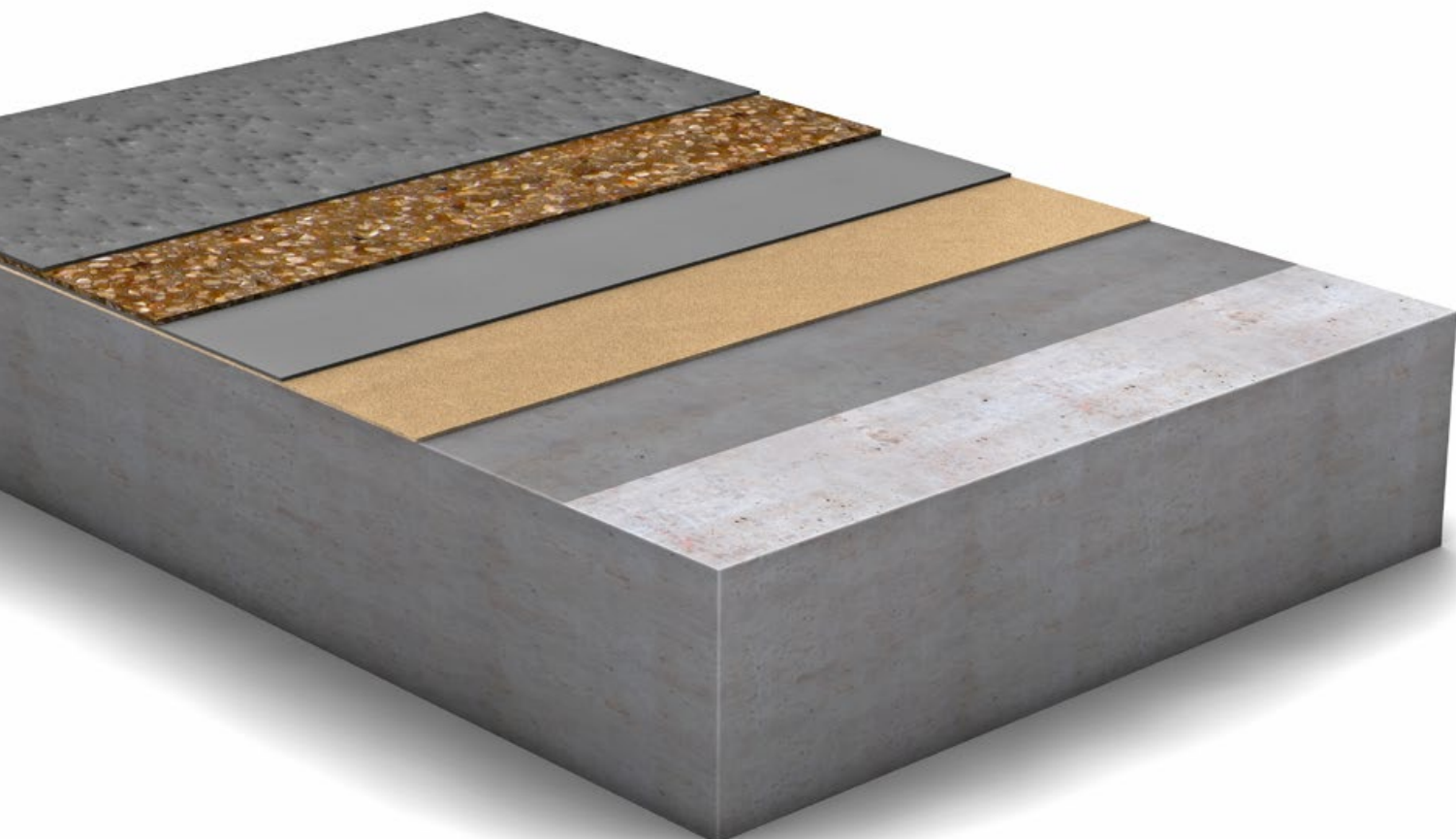





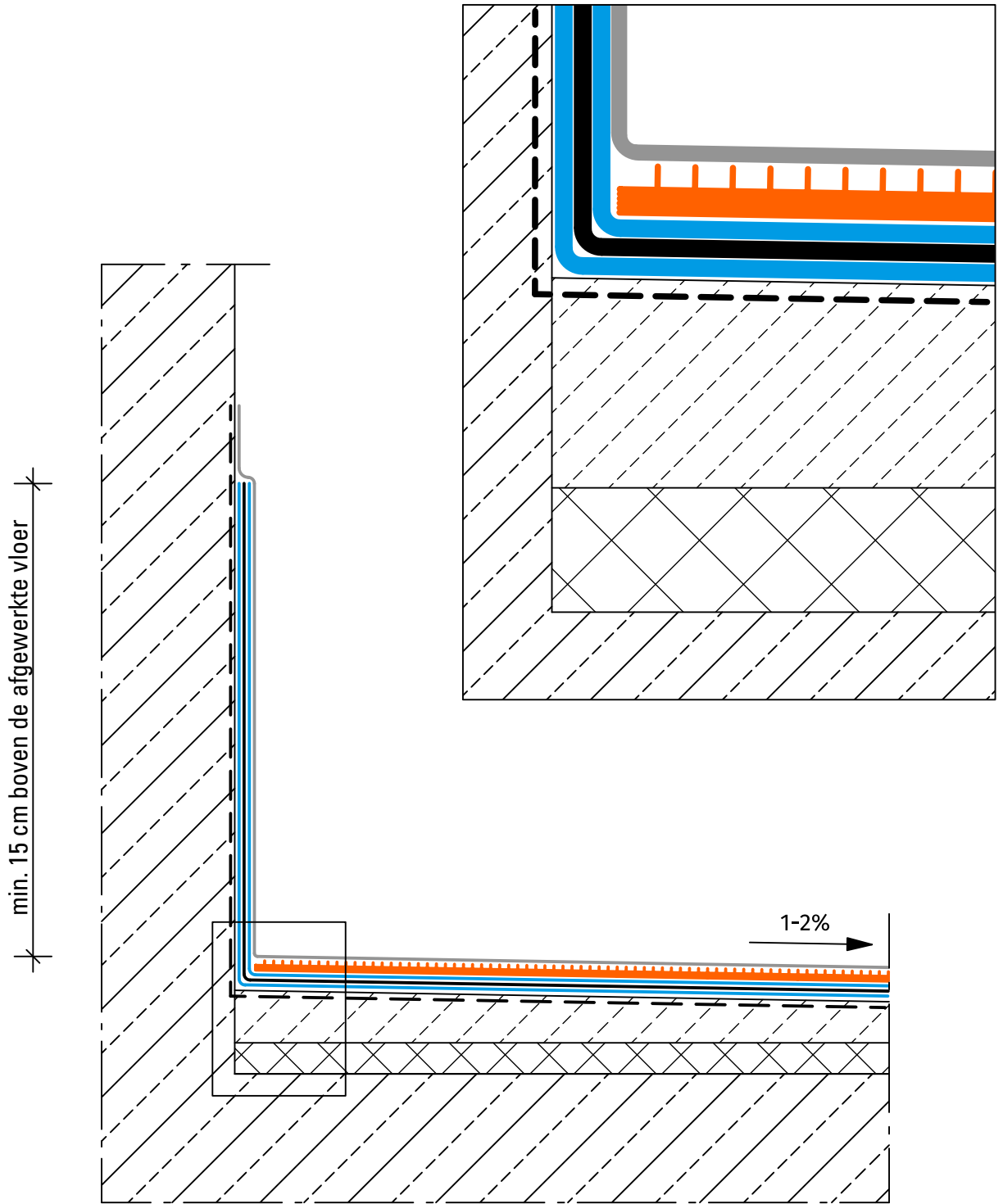

Grondering	MC-DUR TopSpeed SC	ca. 300 g/m ²
Schraaplaag	MC-DUR TopSpeed SC + KZ (1:1)	ca. 1.200 g/m ²
Afdichtingslaag	MC-DUR TopSpeed flex plus	ca. 1.000 g/m ²
Instrooilaag	MC-DUR TopSpeed + KZ (volzat)	ca. 400 g/m ²
Instrooilaag	MC-DUR TopSpeed	ca. 600 g/m ²

KZ = Kwartszand

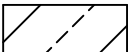
Afdichtingsdetails

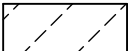

Legende:

-  Onderbouw
-  Drainageplaat
-  Aflopende dekvloer
-  Grondering
-  Afdichtingslaag
-  Weefselvlies
-  Slijtlaag
-  Afdichting







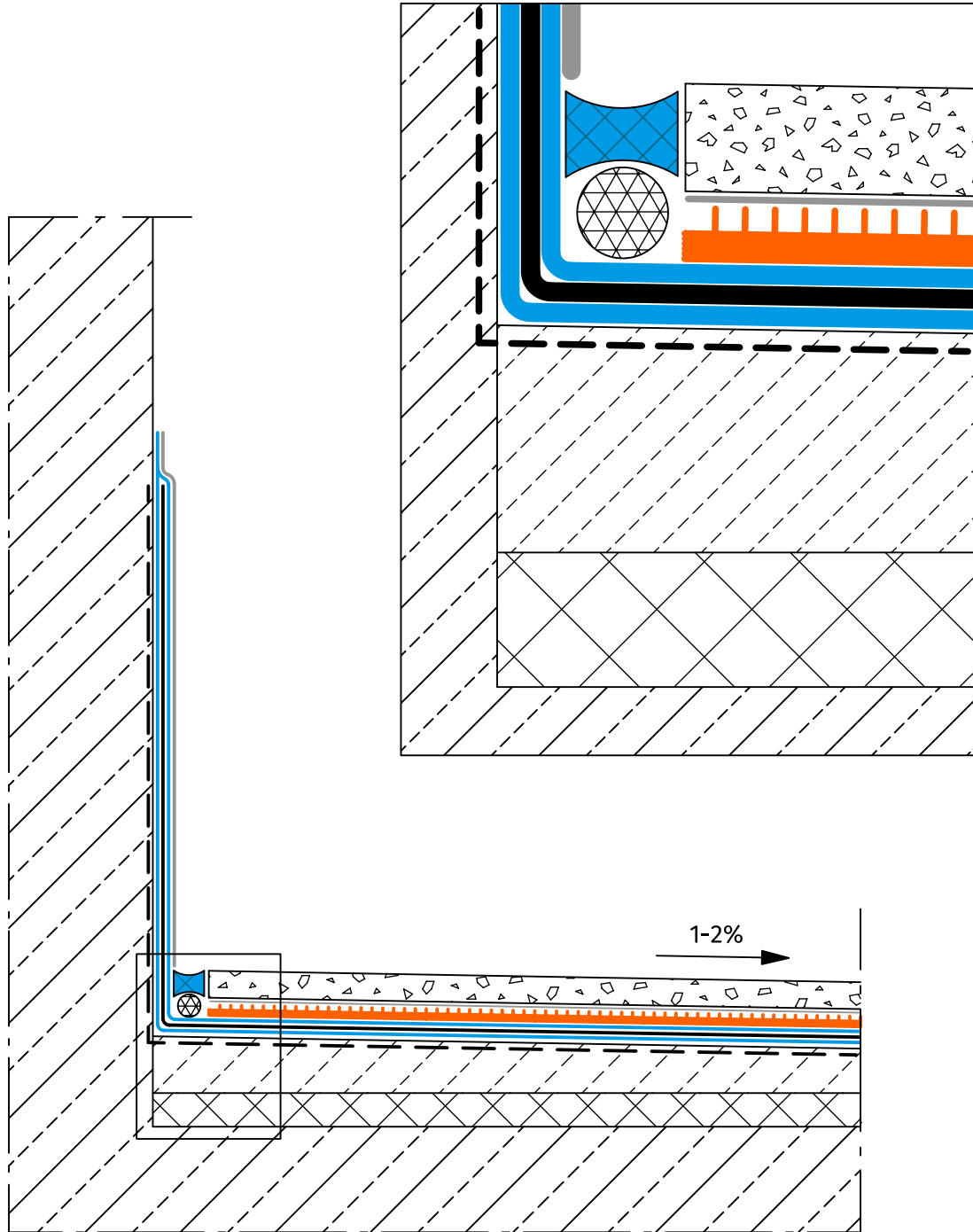

Afdichtingsdetail 01a: Vloer-muurverbinding

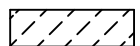
Grondering	MC-DUR 1177 WV-A
Afdichtingslaag	MC-DUR TopSpeed flex plus
Weefselvlies	MC-Floor Tex
Slijtlaag	MC-DUR TopSpeed + Kwartszand
Afdichting	MC-DUR TopSpeed

min. 15 cm boven de afgewerkte vloer



Legende:

-  Drainageplaat
-  Aflopende dekvloer
-  Elastisch afdichtmiddel
-  Voegenvuller
-  Tegels
-  Drainageplaat
-  Afdichtingslaag
-  Weefselvlies
-  Hechtlaag
-  Tegellijm







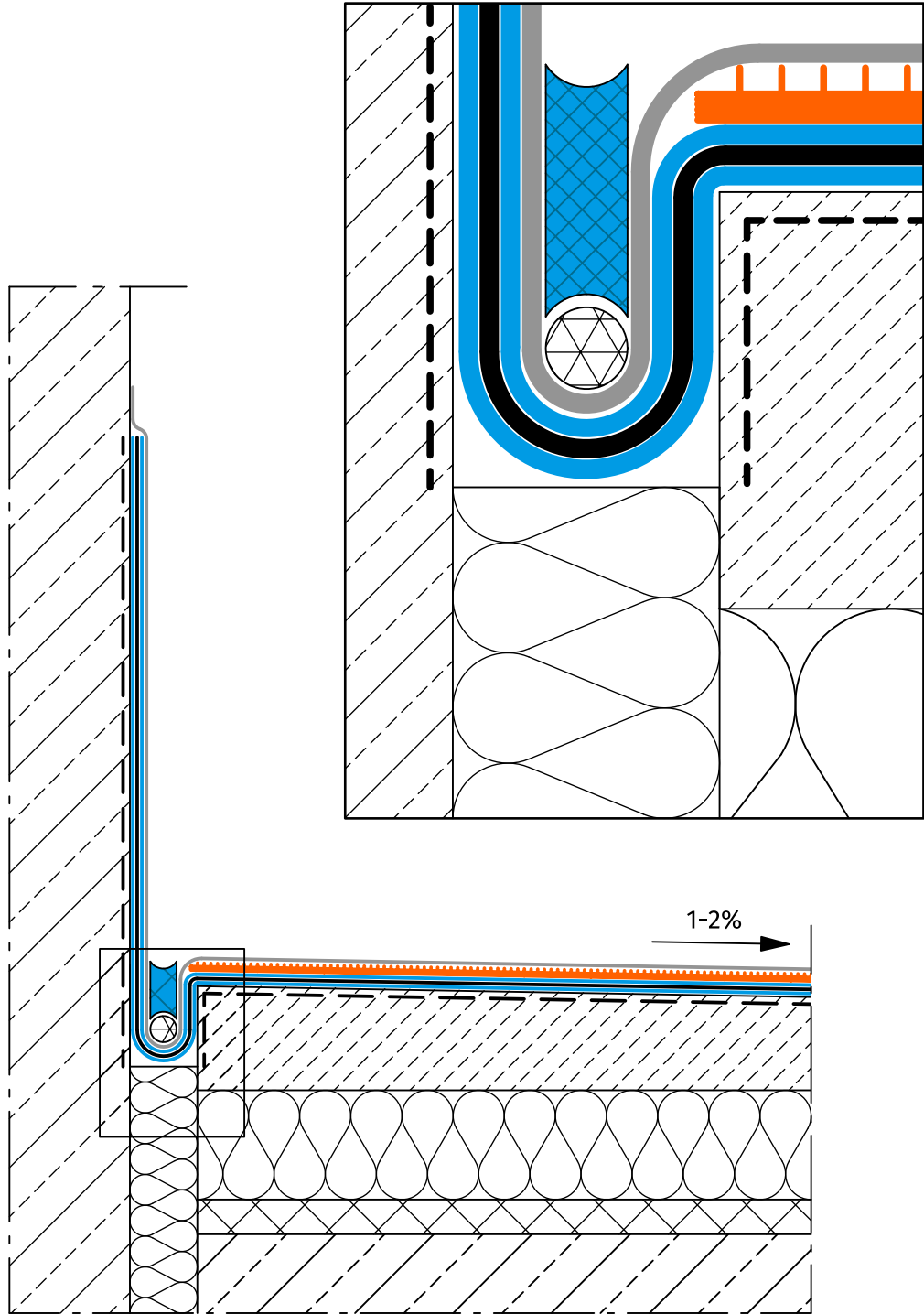

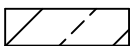

Waterdicht detail 01b: Vloer-wandverbinding met tegels

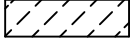
Grondering	MC-DUR 1177 WV-A
Afdichtingslaag	MC-DUR TopSpeed flex plus
Weefselvlies	MC-Floor Tex
Elastisch afdichtmiddel	Mycoflex 488 MS
Voegenvuller	PE-voegenvulmiddel met gesloten cellen
Hechtlaag	MC-DUR TopSpeed flex plus + Kwartszand
Tegellijm	afhankelijk van het materiaal

min. 15 cm boven de afgewerkte vloer

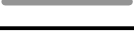

Legende:

-  Onderbouw
-  Drainageplaat
-  Aflopende dekvloer
-  Elastisch afdichtmiddel
-  Voegenvuller
-  Grondering
-  Afdichtingslaag
-  Weefselvlies
-  Slijtlaag
-  Afdichting

Waterdicht detail 02a: Isolatie

Grondering	MC-DUR 1177 WV-A
Afdichtingslaag	MC-DUR TopSpeed flex plus
Weefselvlies	MC-Floor Tex
Elastisch afdichtmiddel	Mycoflex 488 MS
Voegenvuller	PE-voegenvulmiddel met gesloten cellen
Slijtlaag	MC-DUR TopSpeed + Kwartzsand
Afdichting	MC-DUR TopSpeed

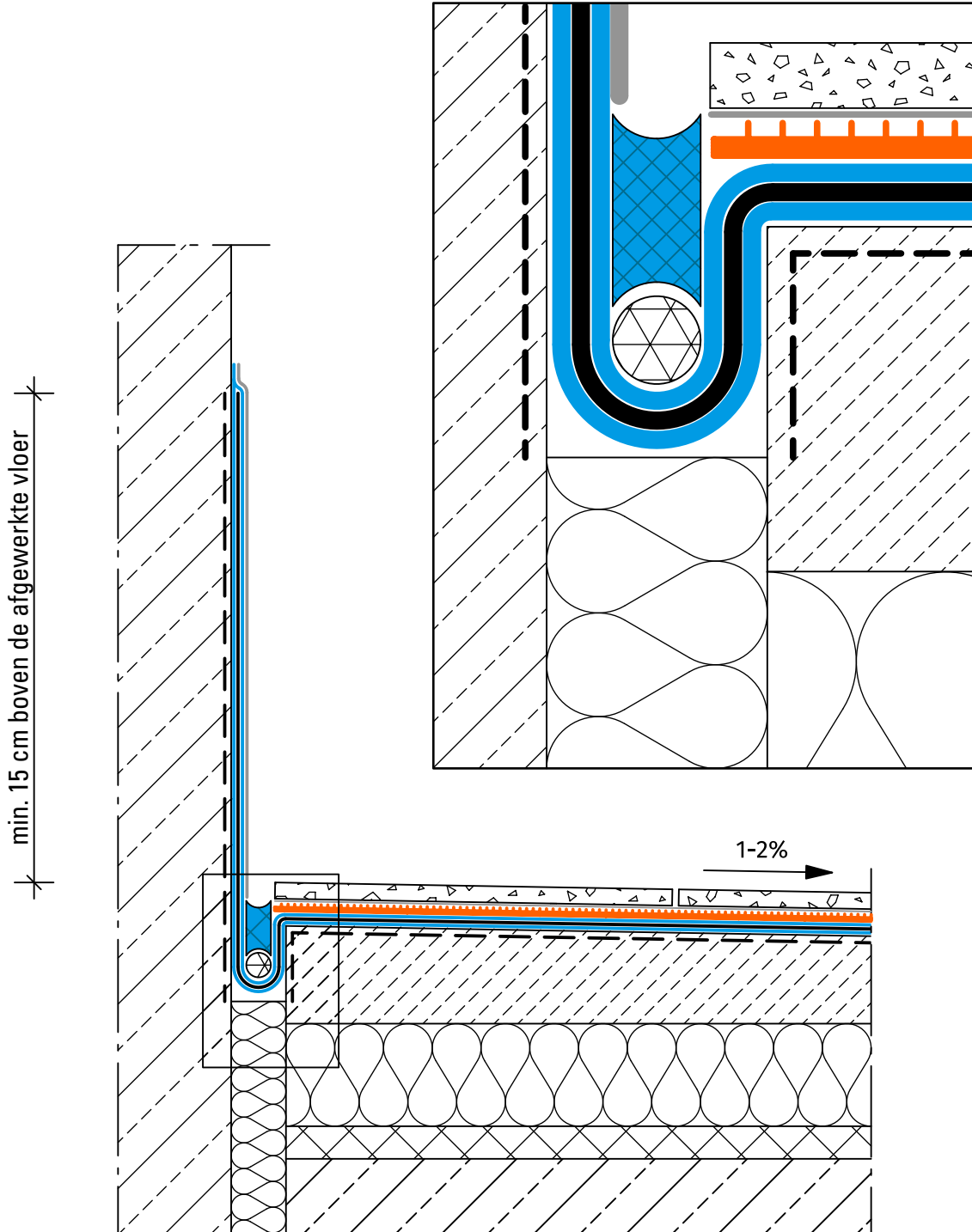

Legende:

-  Drainageplaat
-  Aflopende dekvloer
-  Elastisch afdichtmiddel
-  Voegenvuller
-  Tegels
-  Grondering
-  Afdichtingslaag
-  Weefselvlies
-  Hechtlaag
-  Tegellijm

Waterdicht detail 02b: Isolatie met tegels

Grondering	MC-DUR 1177 WV-A
Afdichtingslaag	MC-DUR TopSpeed flex plus
Weefselvlies	MC-Floor Tex
Elastisch afdichtmiddel	Mycoflex 488 MS
Voegenvuller	PE-voegenvulmiddel met gesloten cellen
Hechtlaag	MC-DUR TopSpeed flex plus + Kwartzsand
Tegellijm	afhankelijk van het materiaal

03a

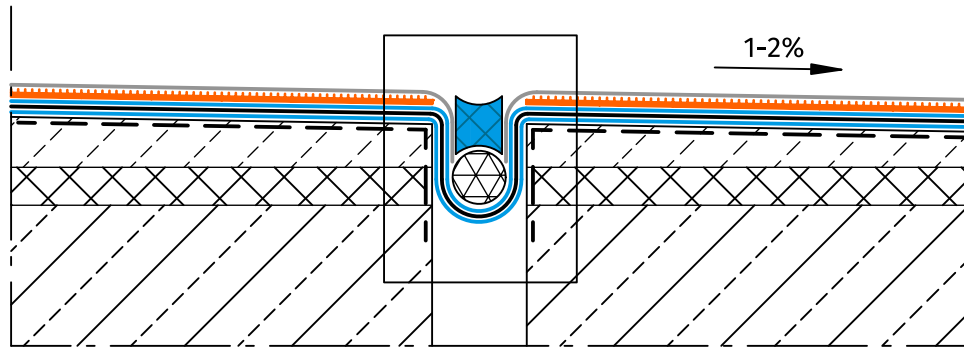
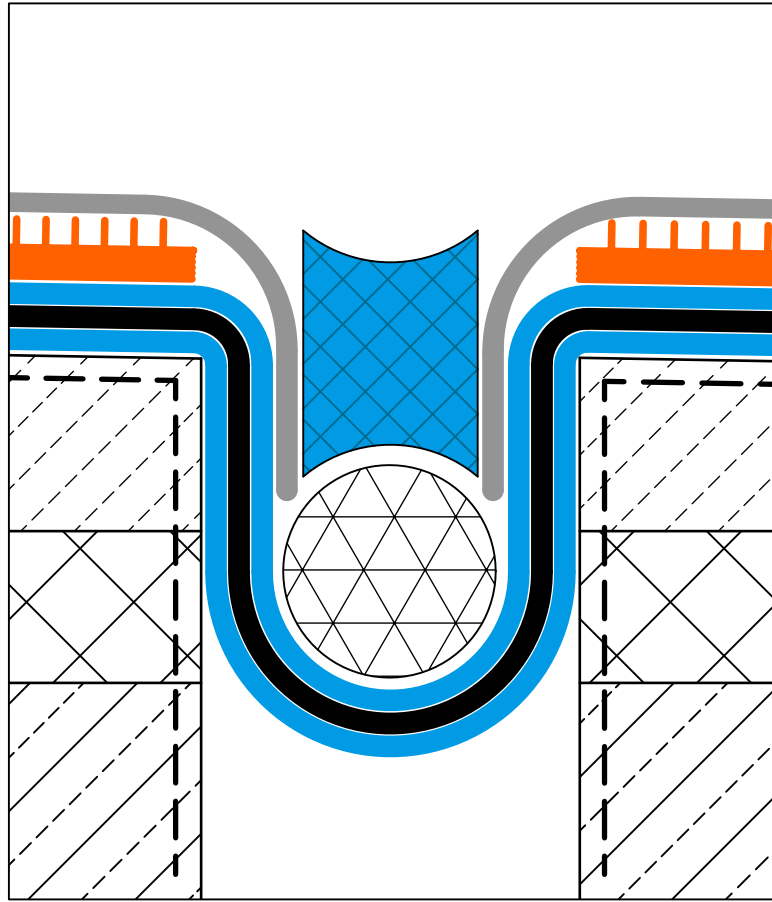

Legende:

-  Onderbouw
-  Drainageplaat
-  Aflopende dekvloer
-  Grondering
-  Afdichtingslaag
-  Weefselvlies
-  Slijtlaag
-  Afdichting
-  Voegenvuller
-  Elastisch afdichtmiddel

Waterdicht detail 03a: Stootvoeg

Grondering	MC-DUR 1177 WV-A
Afdichtingslaag	MC-DUR TopSpeed flex plus
Weefselvlies	MC-Floor Tex
Elastisch afdichtmiddel	Mycoflex 488 MS
Voegenvuller	PE-voegenvulmiddel met gesloten cellen
Hechtlaag	MC-DUR TopSpeed + Kwartszand
Afdichting	MC-DUR TopSpeed

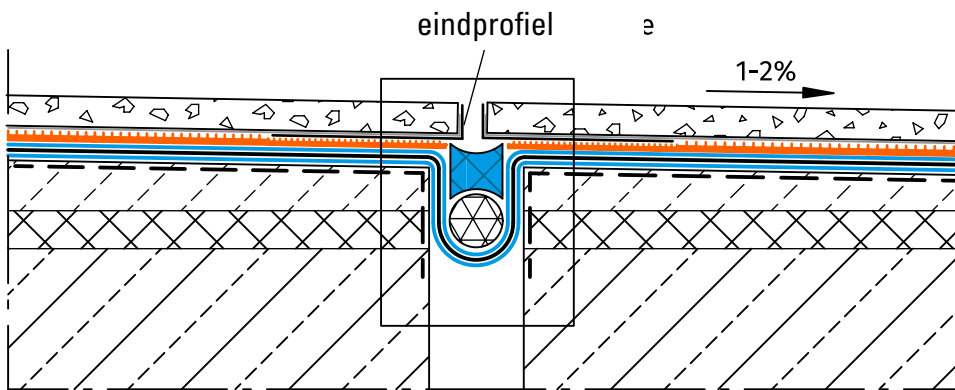
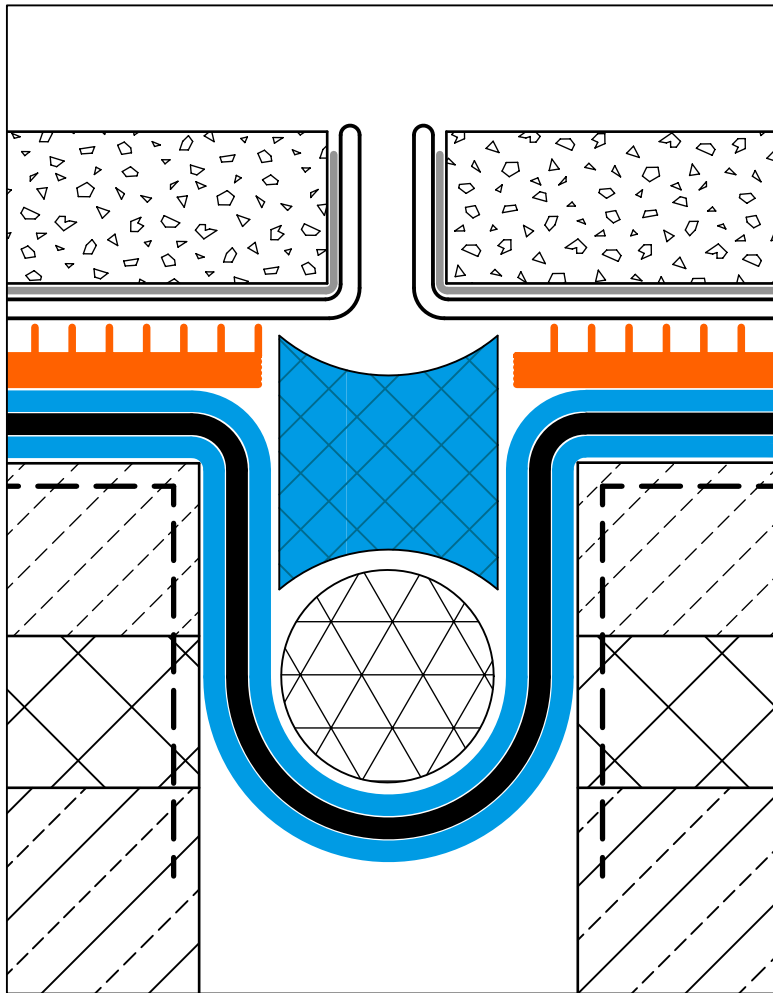

Legende:

-  Drainageplaat
-  Aflopende dekvloer
-  Elastisch afdichtmiddel
-  Voegenvuller
-  Tegels
-  Grondering
-  Afdichtingslaag
-  Weefselvlies
-  Hechtlaag
-  Tegellijm

Waterdicht detail 03b: Stootvoegen met tegels

Grondering	MC-DUR 1177 WV-A
Afdichtingslaag	MC-DUR TopSpeed flex plus
Weefselvlies	MC-Floor Tex
Elastisch afdichtmiddel	Mycoflex 488 MS
Voegenvuller	PE-voegenvulmiddel met gesloten cellen
Hechtlaag	MC-DUR TopSpeed flex plus + Kwartzsand
Tegellijm	afhankelijk van het materiaal

04a

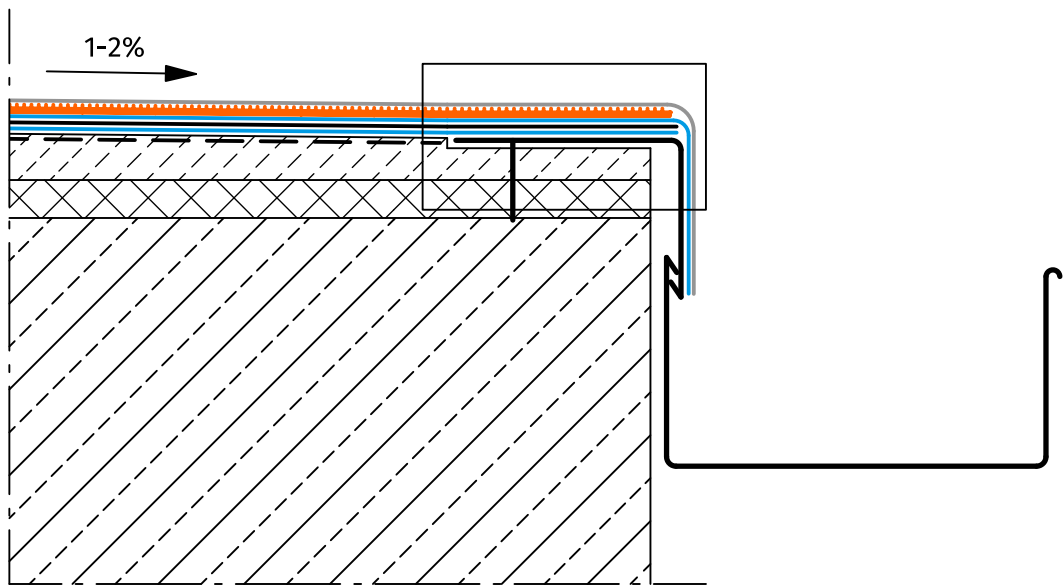
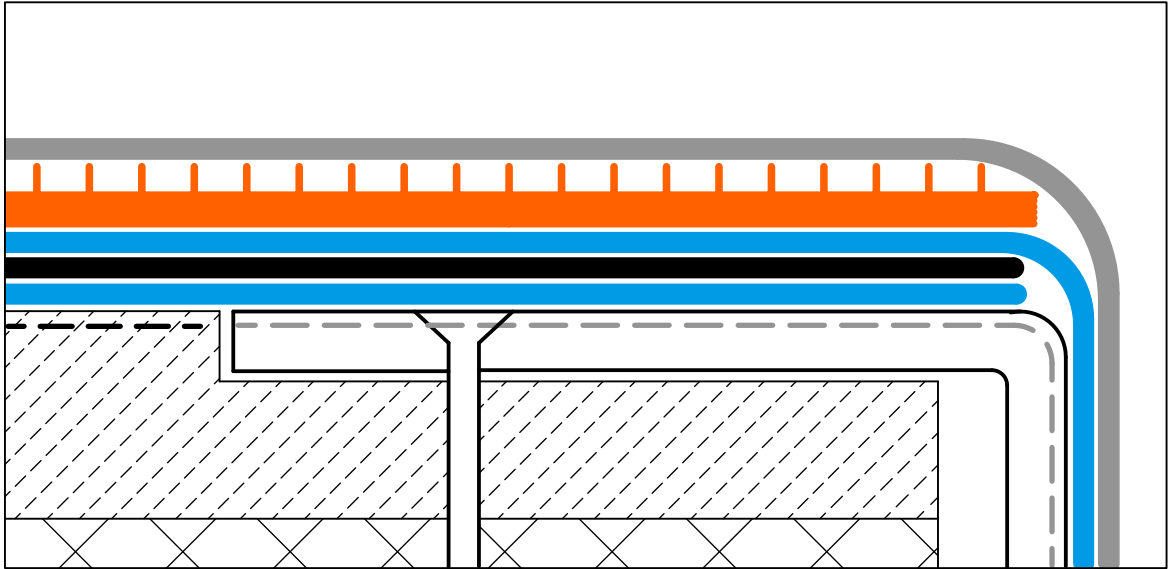

Legende:

-  Onderbouw
-  Drainageplaat
-  Aflopende dekvloer
-  Grondering I
-  Grondering II
-  Afdichtingslaag
-  Weefselvlies
-  Slijtlaag
-  Afdichting

Waterdicht detail 04a: Randafwerking met goot

Grondering I	MC-DUR 1177 WV-A
Grondering II	afhankelijk van het materiaal (zie primerlijst)
Afdichtingslaag	MC-DUR TopSpeed flex plus
Weefselvlies	MC-Floor Tex
Slijtlaag	MC-DUR TopSpeed + Kwartzsand
Afdichting	MC-DUR TopSpeed

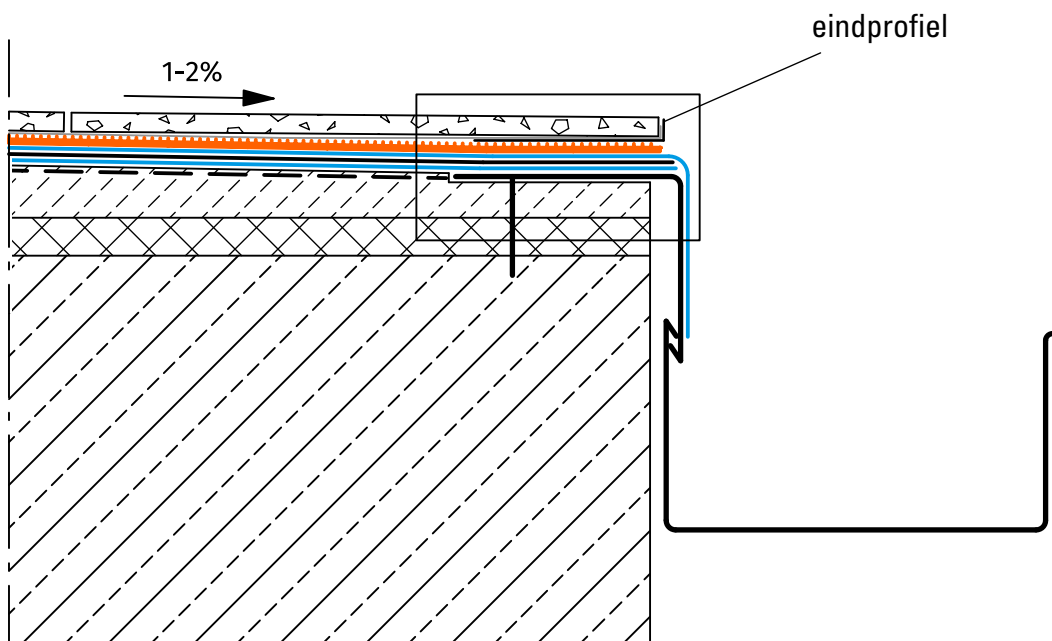
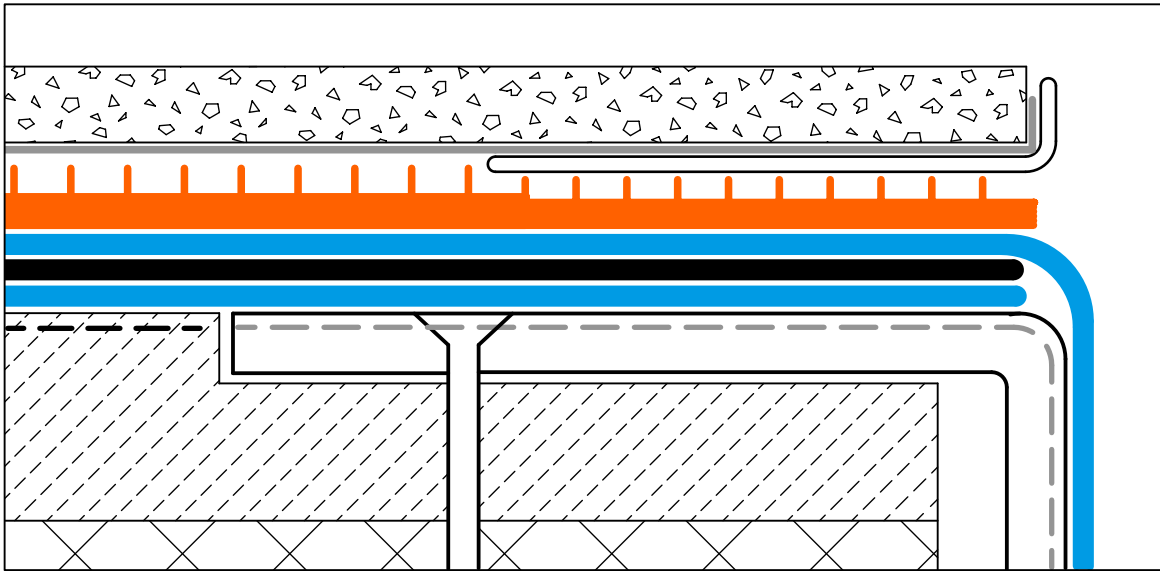

Legende:

-  Onderbouw
-  Drainageplaat
-  Aflopende dekvloer
-  Tegels
-  Grondering I
-  Grondering II
-  Afdichtingslaag
-  Weefselvlies
-  Hechtlaag
-  Tegellijm

Waterdicht detail 04b: Randafwerking met goot en tegels

Grondering I	MC-DUR 1177 WV-A
Grondering II	afhankelijk van het materiaal (zie primerlijst)
Afdichtingslaag	MC-DUR TopSpeed flex plus
Weefselvlies	MC-Floor Tex
Hechtlaag	MC-DUR TopSpeed flex plus + Kwartzand
Tegellijm	afhankelijk van het materiaal

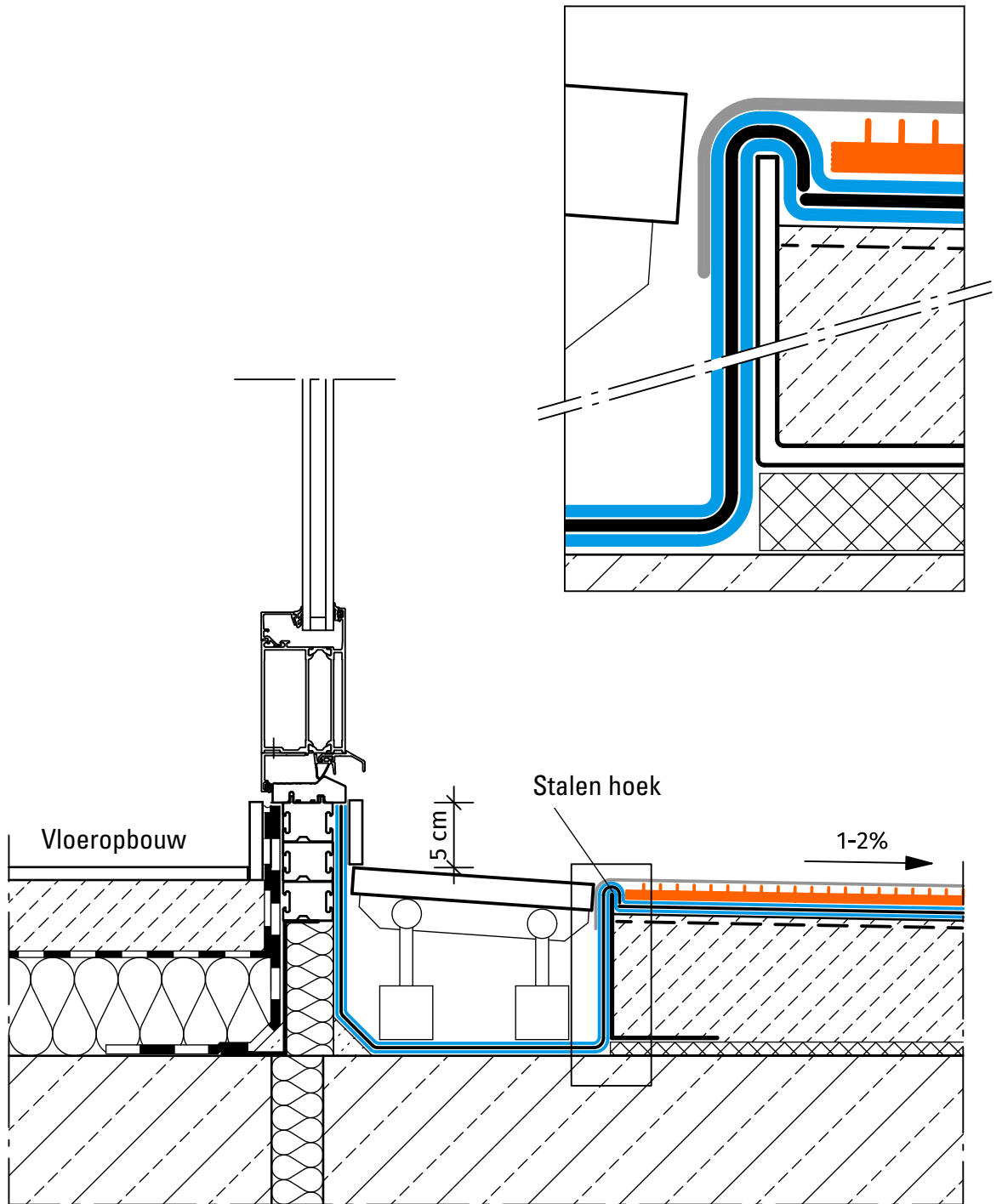

Legende:

-  Onderbouw
-  Drainageplaat
-  Aflopende dekvloer
-  Grondering I
-  Grondering II
-  Afdichtingslaag
-  Weefselvlies
-  Slijtlaag
-  Afdichting

Waterdicht detail 05a: Deuraansluiting 5 cm

Grondering I	MC-DUR 1177 WV-A
Grondering II	afhankelijk van het materiaal (zie primerlijst)
Afdichtingslaag	MC-DUR TopSpeed flex plus
Weefselvlies	MC-Floor Tex
Slijtlaag	MC-DUR TopSpeed + Kwartszand
Afdichting	MC-DUR TopSpeed

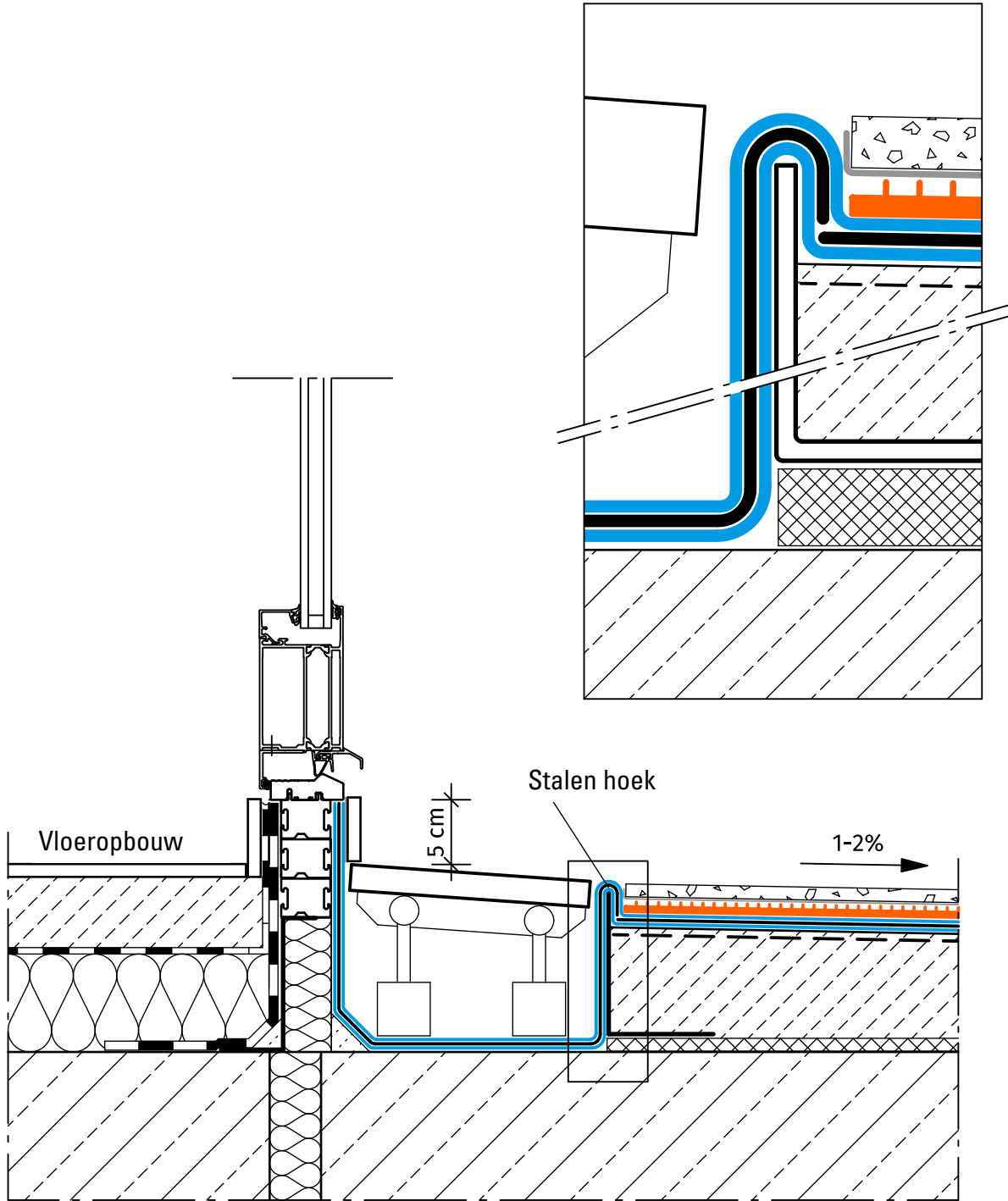

Legende:







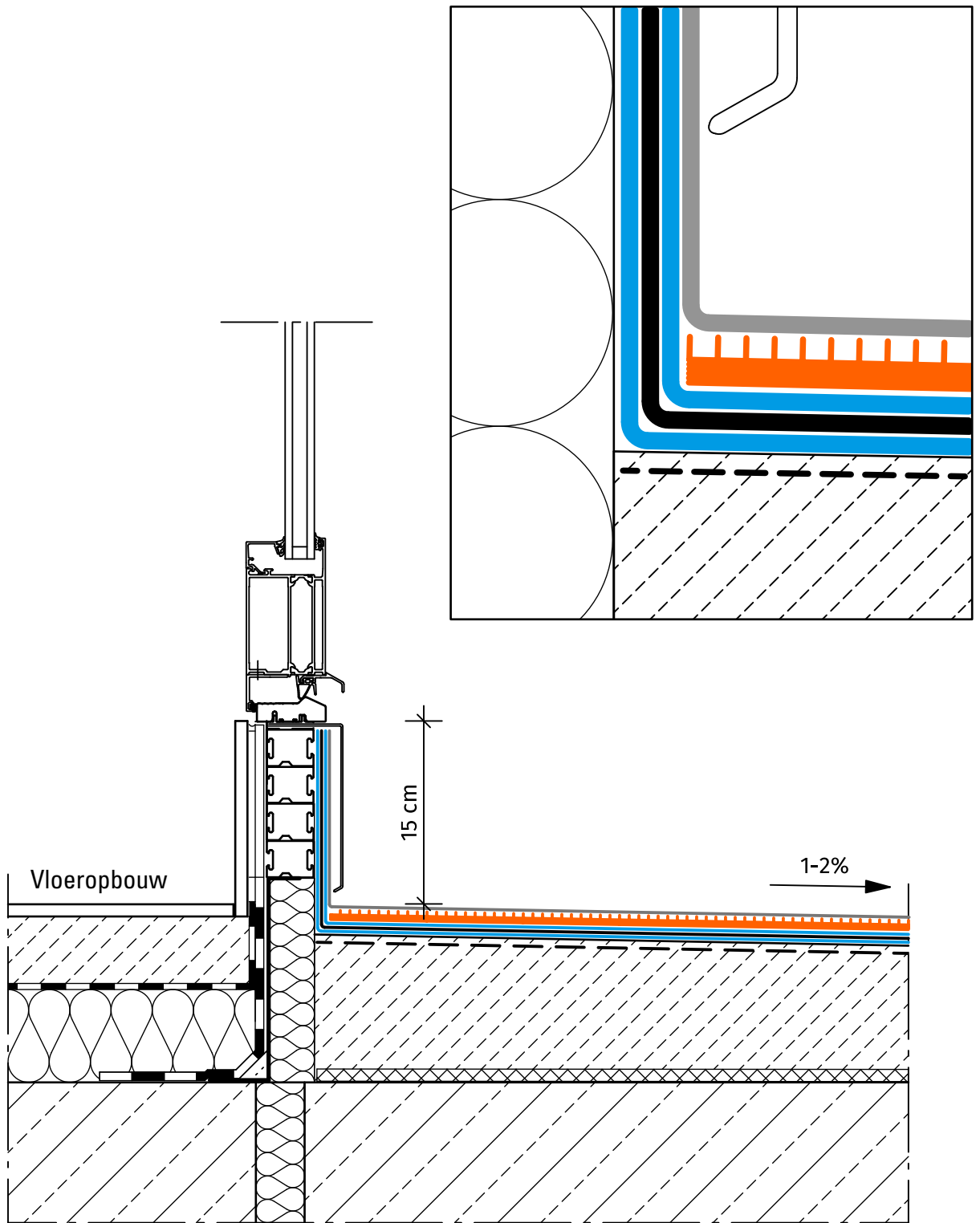

-  Onderbouw
-  Drainageplaat
-  Aflopende dekvloer
-  Tegels
-  Grondering I
-  Grondering II
-  Afdichtingslaag
-  Weefselvlies
-  Hechtlaag
-  Tegellijm

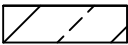
Waterdicht detail 05b: Deuraansluiting 5 cm met tegels

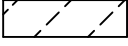
Grondering I	MC-DUR 1177 WV-A
Grondering II	afhankelijk van het materiaal (zie primerlijst)
Afdichtingslaag	MC-DUR TopSpeed flex plus
Weefselvlies	MC-Floor Tex
Hechtlaag	MC-DUR TopSpeed flex plus + Kwartzand
Tegellijm	afhankelijk van het materiaal



Legende:

-  Onderbouw
-  Drainageplaat
-  Aflopende dekvloer
-  Grondering
-  Afdichtingslaag
-  Weefselvlies
-  Slijtlaag
-  Afdichting

Waterdicht detail 06a: Deuraansluiting 15 cm

Grondering	MC-DUR 1177 WV-A
Afdichtingslaag	MC-DUR TopSpeed flex plus
Weefselvlies	MC-Floor Tex
Hechtlaag	MC-DUR TopSpeed + Kwartzand
Afdichting	MC-DUR TopSpeed

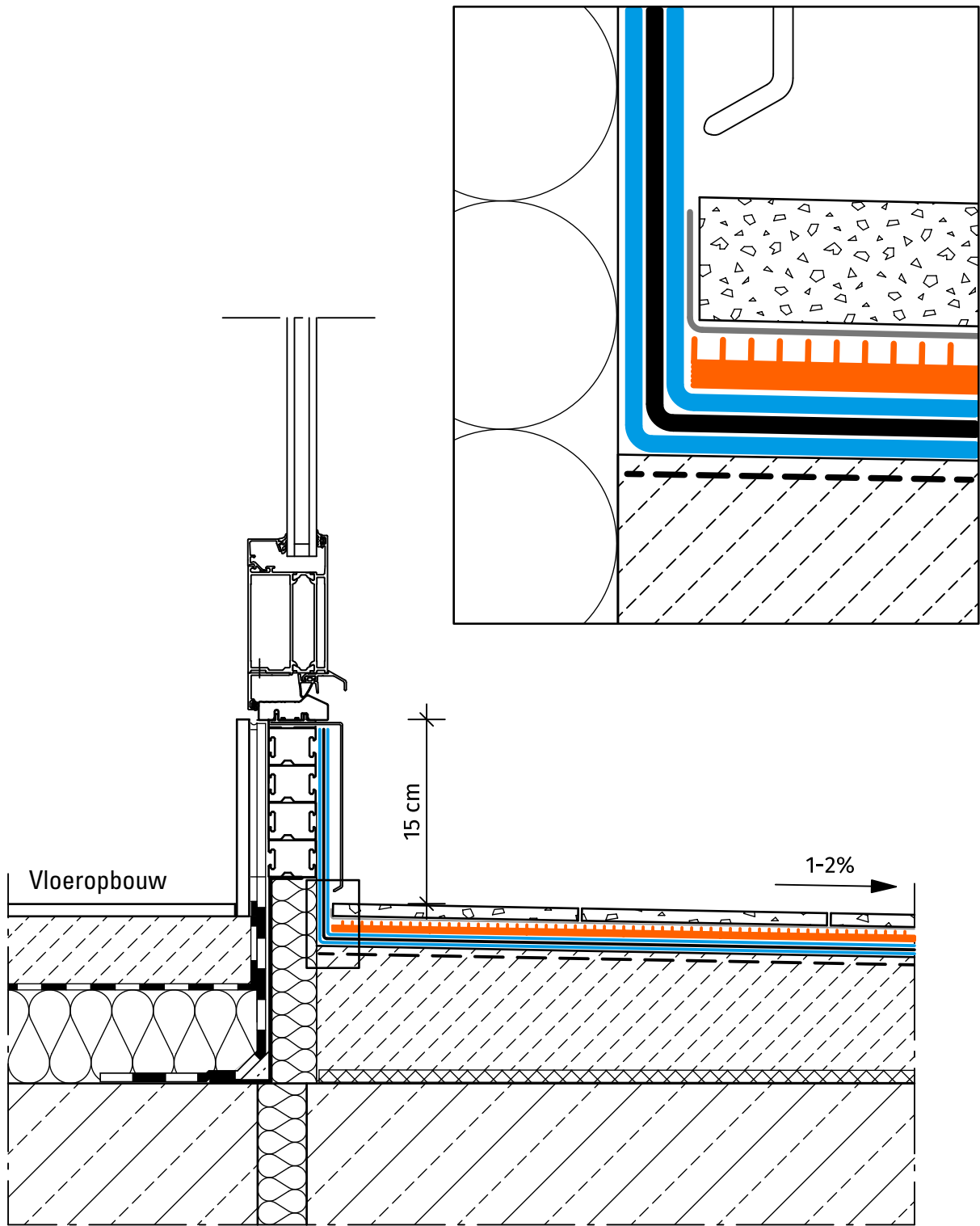

Legende:

-  Onderbouw
-  Drainageplaat
-  Aflopende dekvloer
-  Tegels
-  Grondering
-  Afdichtingslaag
-  Weefselvlies
-  Hechtlaag
-  Tegelijm

Waterdicht detail 06b: Deuraansluiting 15 cm met tegels







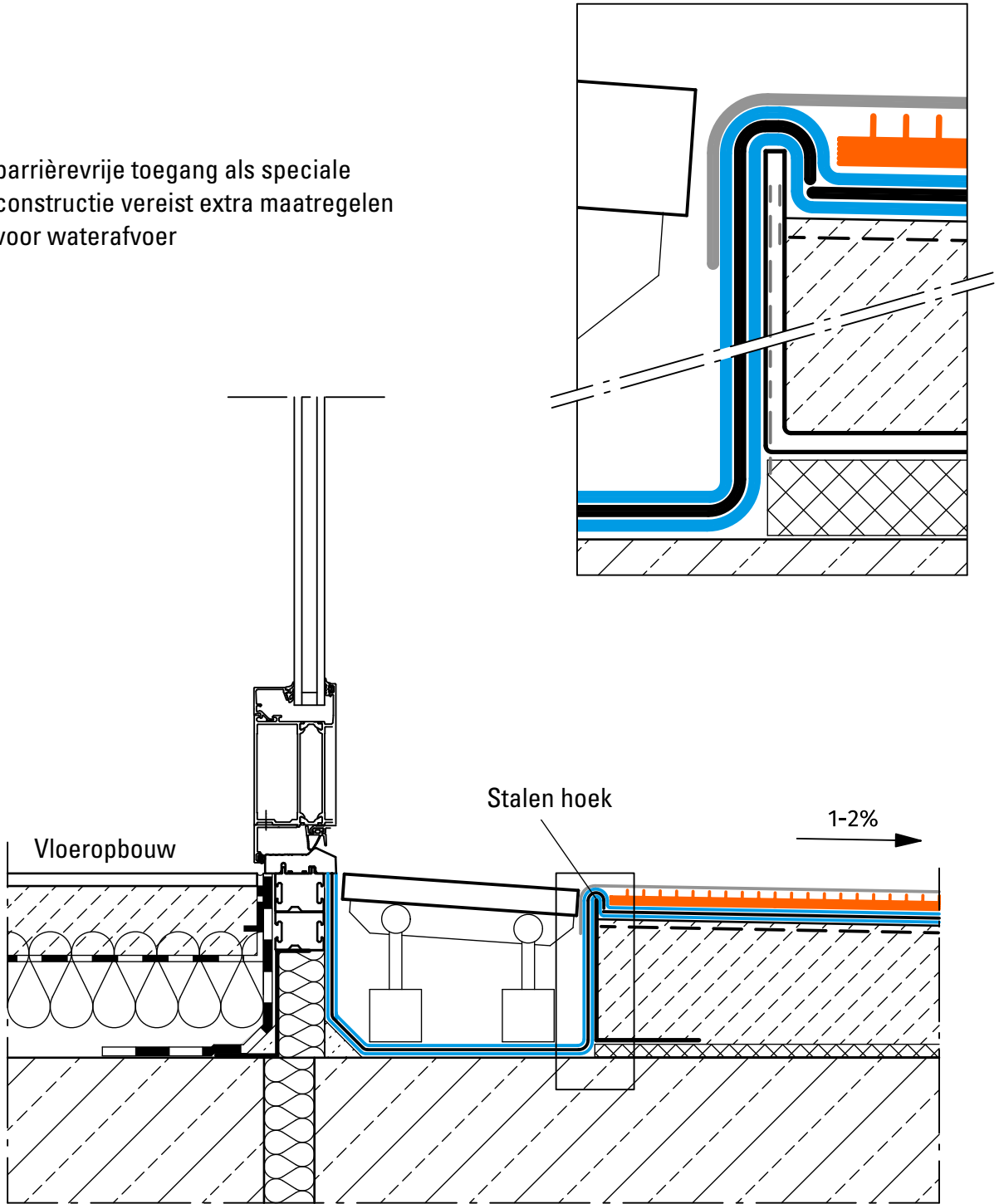

Grondering	MC-DUR 1177 WV-A
Afdichtingslaag	MC-DUR TopSpeed flex plus
Weefselvlies	MC-Floor Tex
Hechtlaag	MC-DUR TopSpeed flex plus + Kwartzand
Tegelijm	afhankelijk van het materiaal

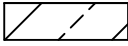
07a

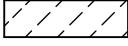
barrièrevrije toegang als speciale constructie vereist extra maatregelen voor waterafvoer



Legende:

-  Onderbouw
-  Drainageplaat
-  Aflopende dekvloer
-  Grondering I
-  Grondering II
-  Afdichtingslaag
-  Weefselvlies
-  Slijtlaag
-  Afdichting

Waterdicht detail 07a: Deuraansluiting barrièrevrij

Grondering I	MC-DUR 1177 WV-A
Grondering II	afhankelijk van het materiaal (zie primerlijst)
Afdichtingslaag	MC-DUR TopSpeed flex plus
Weefselvlies	MC-Floor Tex
Slijtlaag	MC-DUR TopSpeed + Kwartszand
Afdichting	MC-DUR TopSpeed

barrièrevrije toegang als speciale constructie vereist extra maatregelen voor waterafvoer

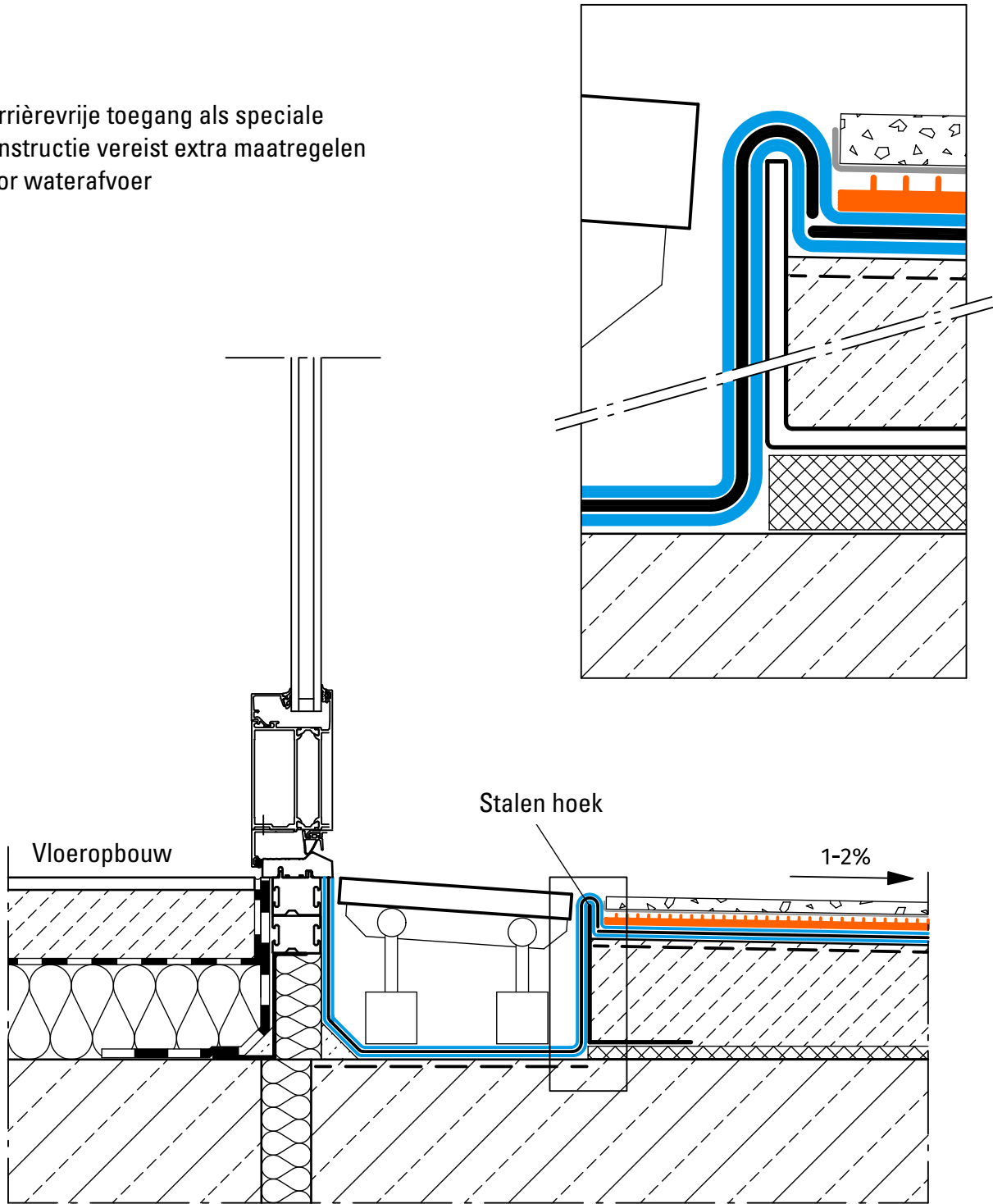

Legende:

- Onderbouw
- Drainageplaat
- Aflopende dekvloer
- Grondering I
- Grondering II
- Afdichtingslaag
- Weefselvlies
- Hechtlaag
- Tegellijm

Waterdicht detail 07b: Deuraansluiting barrièrevrij met tegels

Grondering I	MC-DUR 1177 WV-A
Grondering II	afhankelijk van het materiaal (zie primerlijst)
Afdichtingslaag	MC-DUR TopSpeed flex plus
Weefselvlies	MC-Floor Tex
Hechtlaag	MC-DUR TopSpeed flex plus + Kwartzand
Tegellijm	afhankelijk van het materiaal

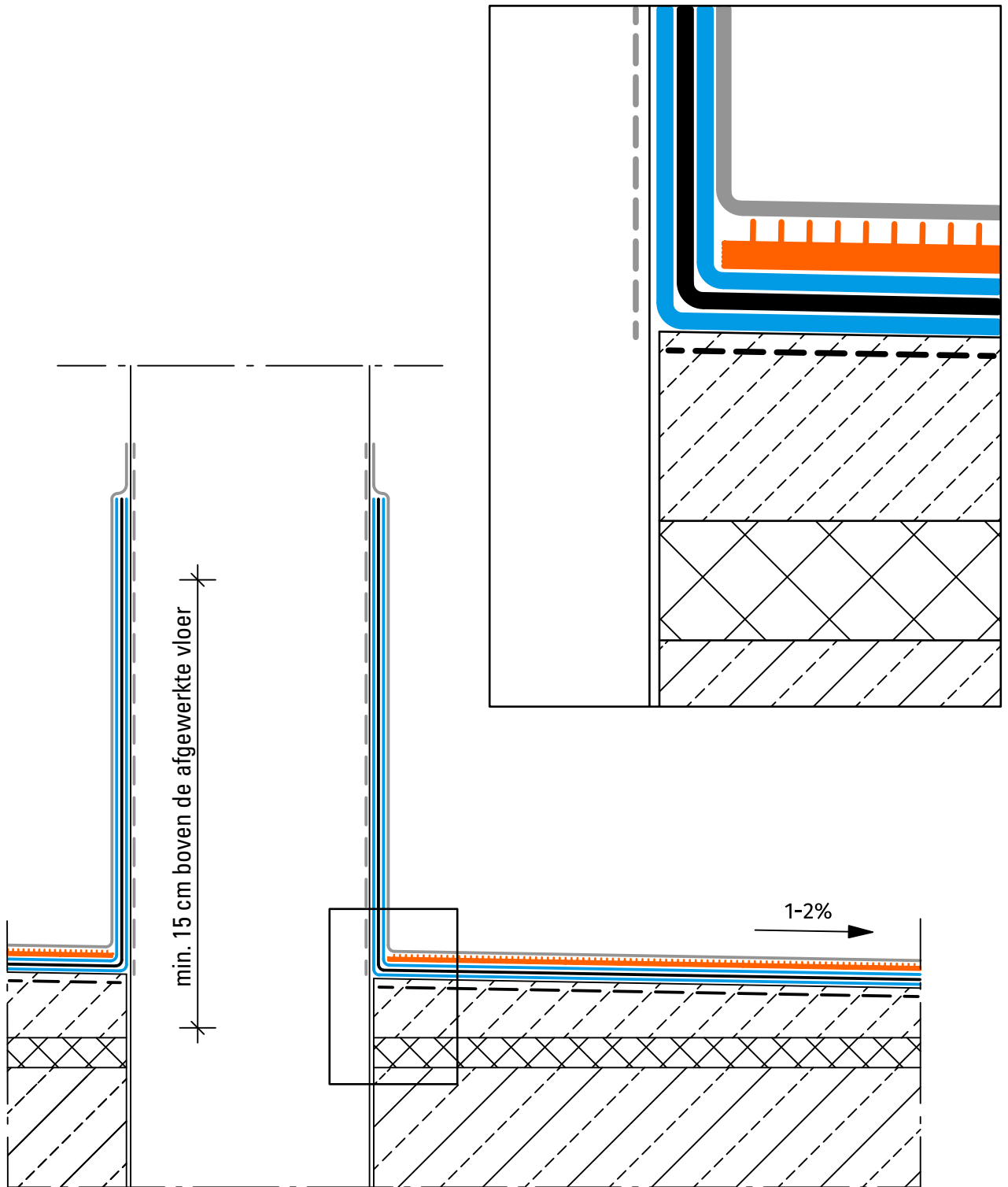

Legende:







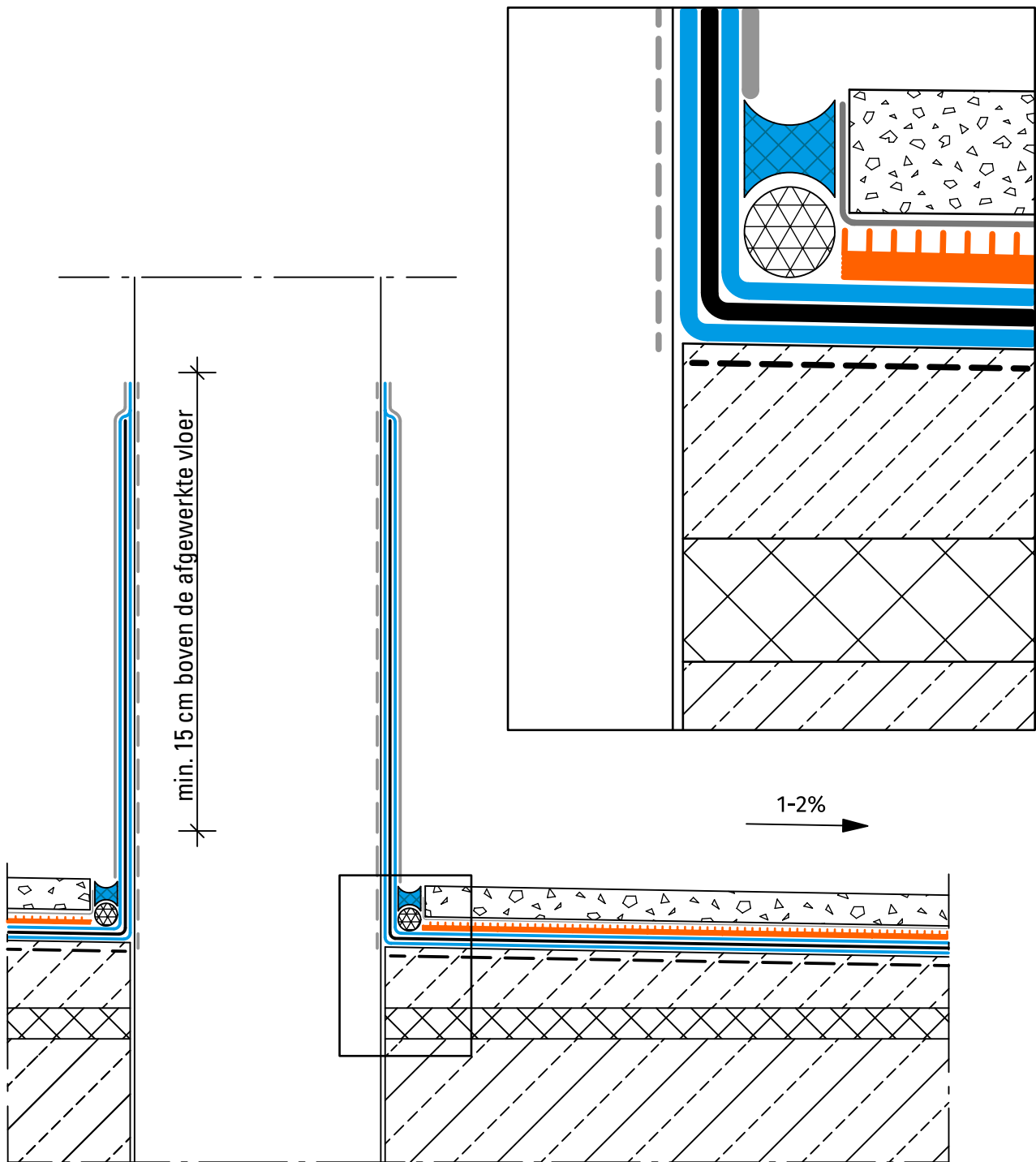

-  Onderbouw
-  Drainageplaat
-  Aflopende dekvloer
-  Grondering I
-  Grondering II
-  Afdichtingslaag
-  Weefselvlies
-  Slijtlaag
-  Afdichting

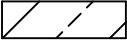
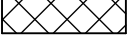
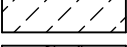
Waterdicht detail 08a: Buisdoorvoer

Grondering I	MC-DUR 1177 WV-A
Grondering II	afhankelijk van het materiaal (zie primerlijst)
Afdichtingslaag	MC-DUR TopSpeed flex plus
Weefselvlies	MC-Floor Tex
Slijtlaag	MC-DUR TopSpeed + Kwartszand
Afdichting	MC-DUR TopSpeed

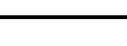
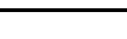

Legende:

-  Onderbouw
-  Drainageplaat
-  Aflopende dekvloer
-  Tegels
-  Elastisch afdichtmiddel
-  Voegenvuller
-  Grondering I
-  Grondering II
-  Afdichtingslaag
-  Weefselvlies
-  Hechtlaag
-  Tegellijm







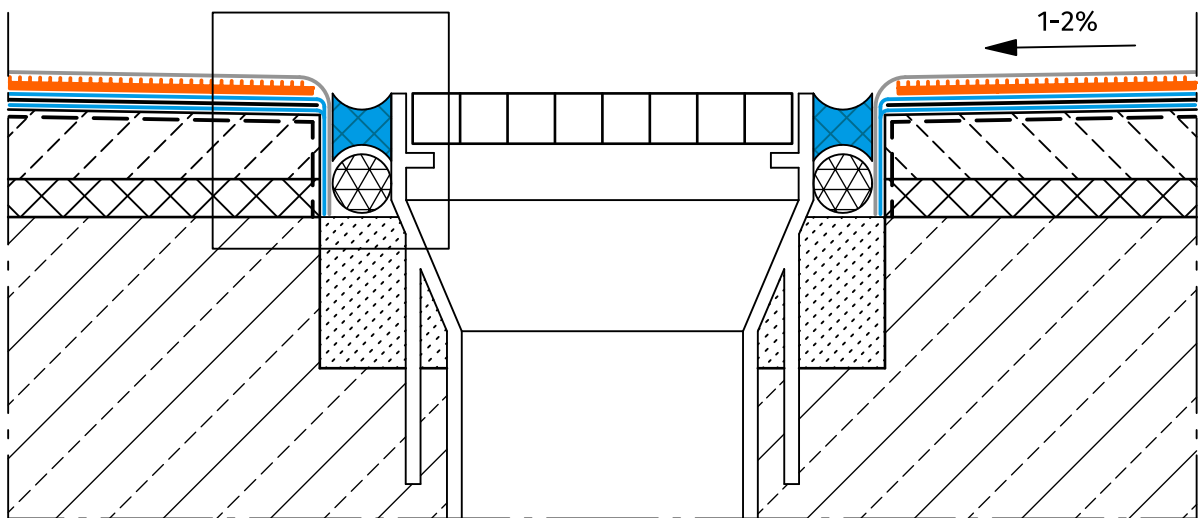
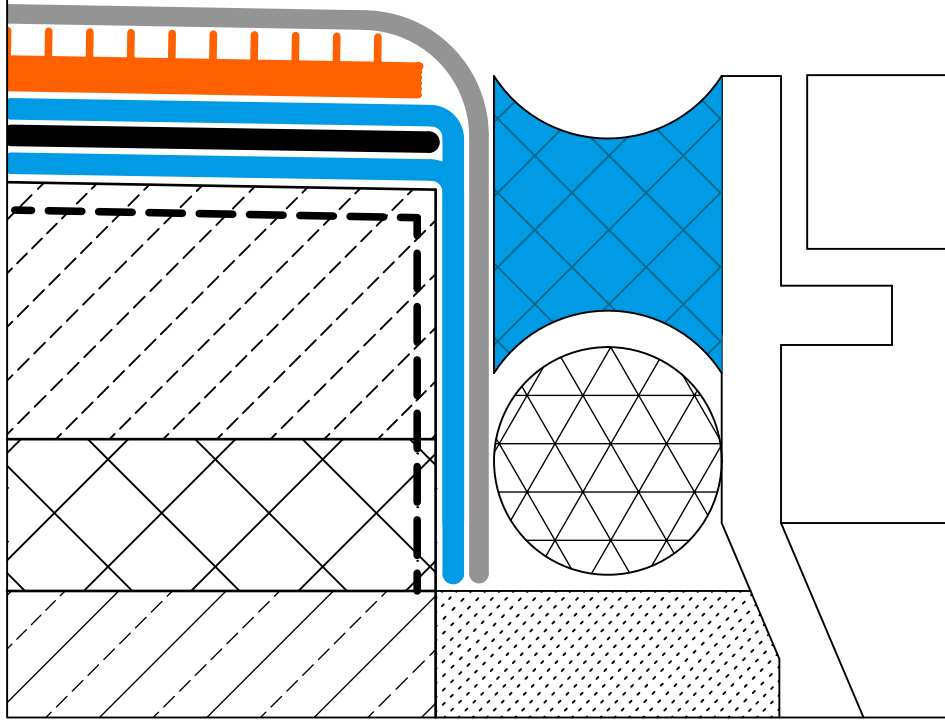

Waterdicht detail 08b: Buisdoorvoer met tegels

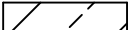
Grondering I	MC-DUR 1177 WV-A
Grondering II	afhankelijk van het materiaal (zie primerlijst)
Afdichtingslaag	MC-DUR TopSpeed flex plus
Weefselvlies	MC-Floor Tex
Elastisch afdichtmiddel	Mycoflex 488 MS
Voegenvuller	PE-voegenvulmiddel met gesloten cellen
Hechtlaag	MC-DUR TopSpeed flex plus + Kwartzand
Tegellijm	afhankelijk van het materiaal

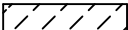
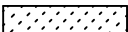
09a



Legende:







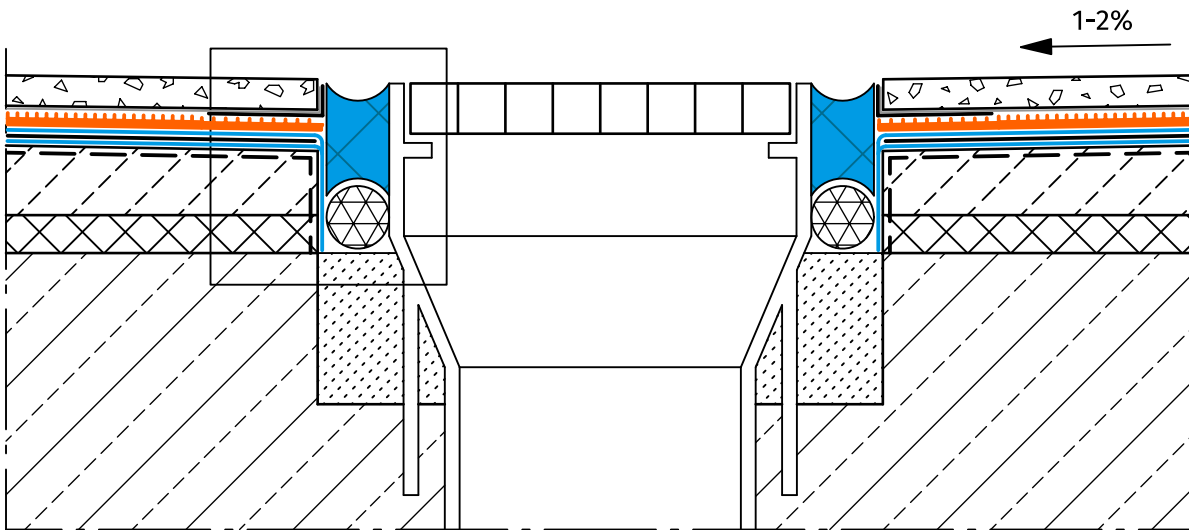
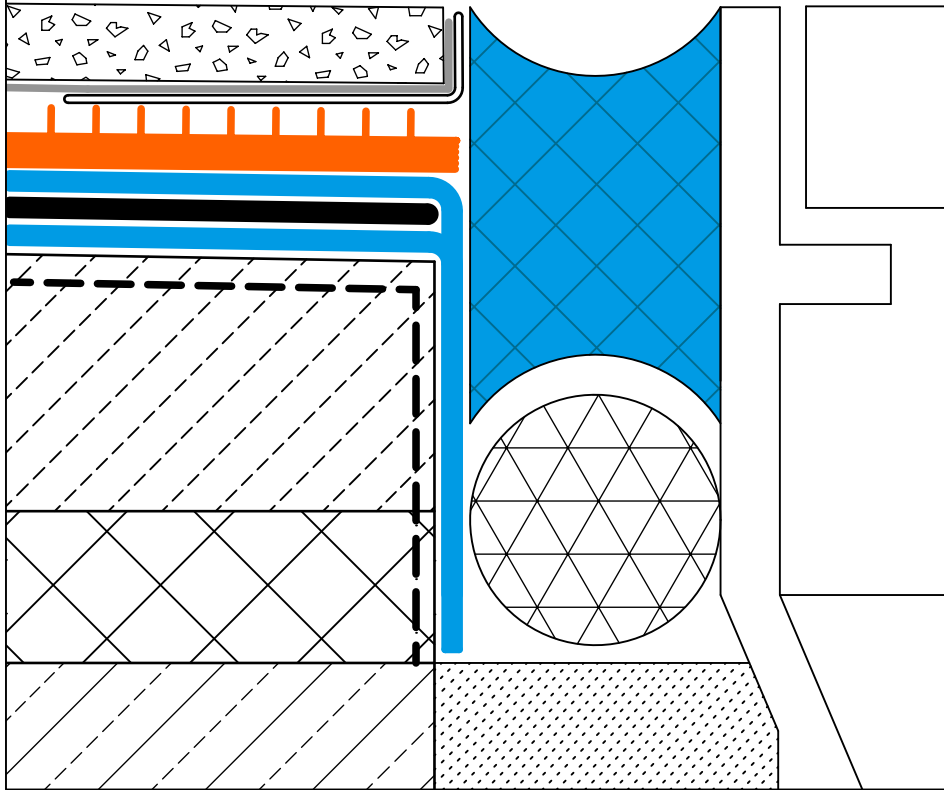

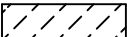

-  Onderbouw
-  Drainageplaat
-  Aflopende dekvloer
-  Mortel
-  Elastisch afdichtmiddel
-  Voegenvuller
-  Grondering
-  Afdichtingslaag
-  Slijtlaag
-  Afdichting

Waterdicht detail 09a: Geul zonder flens

Grondering	MC-DUR 1177 WV-A
Afdichtingslaag	MC-DUR TopSpeed flex plus
Elastisch afdichtmiddel	Mycoflex 488 MS
Voegenvuller	PE-voegenvulmiddel met gesloten cellen
Slijtlaag	MC-DUR TopSpeed + Kwartszand
Afdichting	MC-DUR TopSpeed



Legende:

-  Drainageplaat
-  Mortel
-  Aflopende dekvloer
-  Elastisch afdichtmiddel
-  Voegenvuller
-  Tegels
-  Grondering
-  Afdichtingslaag
-  Weefselvlies
-  Hechtlaag
-  Tegellijm







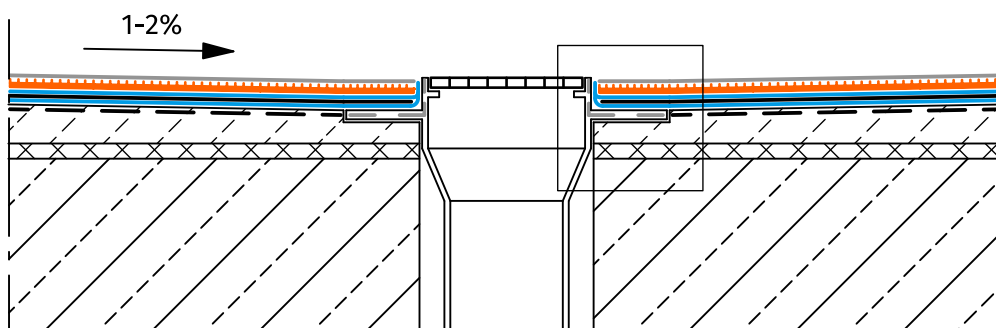
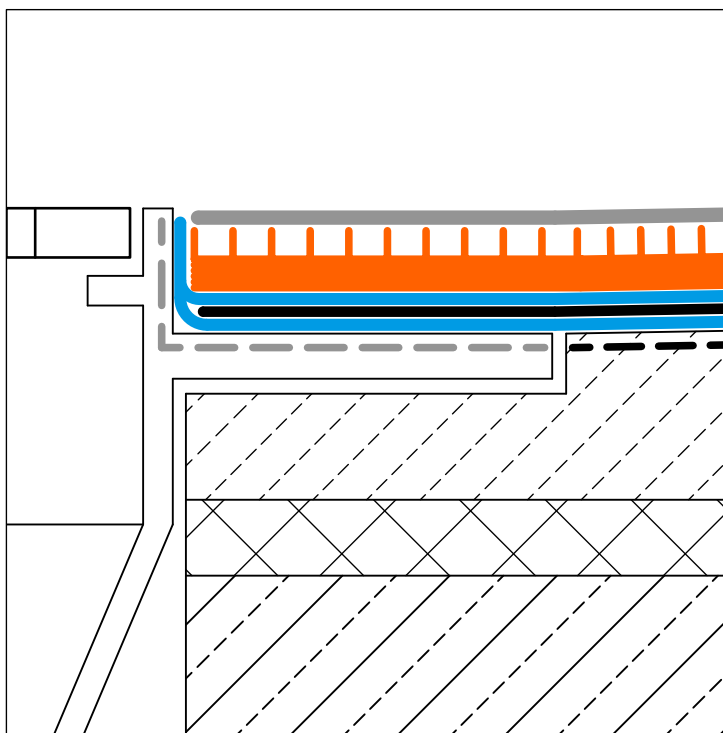

Waterdicht detail 09b: Geul zonder flens met tegels

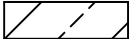
Grondering	MC-DUR 1177 WV-A
Afdichtingslaag	MC-DUR TopSpeed flex plus
Weefselvlies	MC-Floor Tex
Elastisch afdichtmiddel	Mycoflex 488 MS
Voegenvuller	PE-voegenvulmiddel met gesloten cellen
Hechtlaag	MC-DUR TopSpeed flex plus + Kwartzand
Tegellijm	afhankelijk van het materiaal

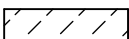
10a



Legende:

-  Onderbouw
-  Drainageplaat
-  Aflopende dekvloer
-  Grondering I
-  Grondering II
-  Afdichtingslaag
-  Weefselvlies
-  Slijtlaag
-  Afdichting

Waterdicht detail 10a: Geul zonder flens

Grondering I	MC-DUR 1177 WV-A
Grondering II	afhankelijk van het materiaal (zie primerlijst)
Afdichtingslaag	MC-DUR TopSpeed flex plus
Elastisch afdichtmiddel	Mycoflex 488 MS
Slijtlaag	MC-DUR TopSpeed + Kwartszand
Afdichting	MC-DUR TopSpeed

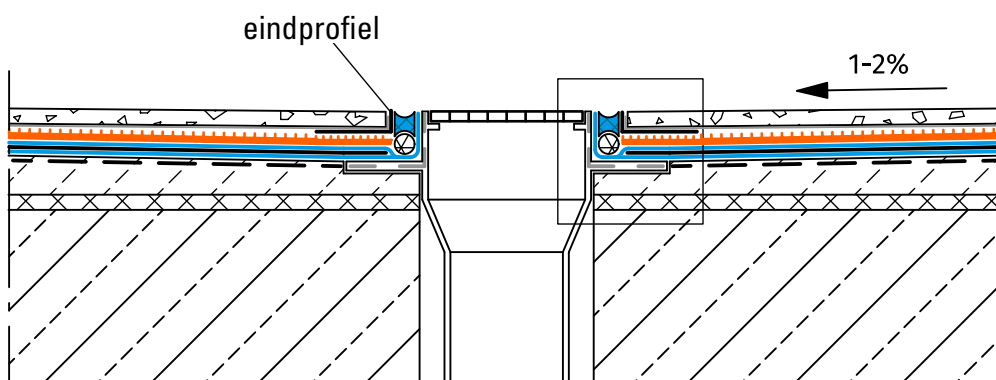
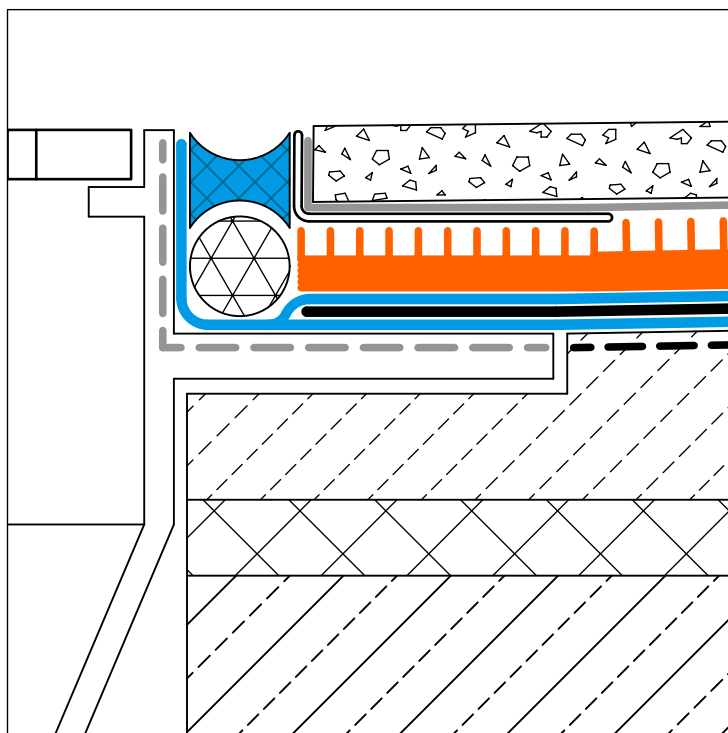

Legende:

	Onderbouw
	Aflopende dekvloer
	Drainageplaat
	Tegels
	Grondering I
	Grondering II
	Afdichtingslaag
	Weefselvlies
	Hechtlaag
	Tegellijm

Waterdicht detail 10b: Geul met flens en tegels

Grondering I	MC-DUR 1177 WV-A
Grondering II	afhankelijk van het materiaal (zie primerlijst)
Afdichtingslaag	MC-DUR TopSpeed flex plus
Weefselvlies	MC-Floor Tex
Hechtlaag	MC-DUR TopSpeed flex plus + Kwartzand
Tegellijm	afhankelijk van het materiaal

11a

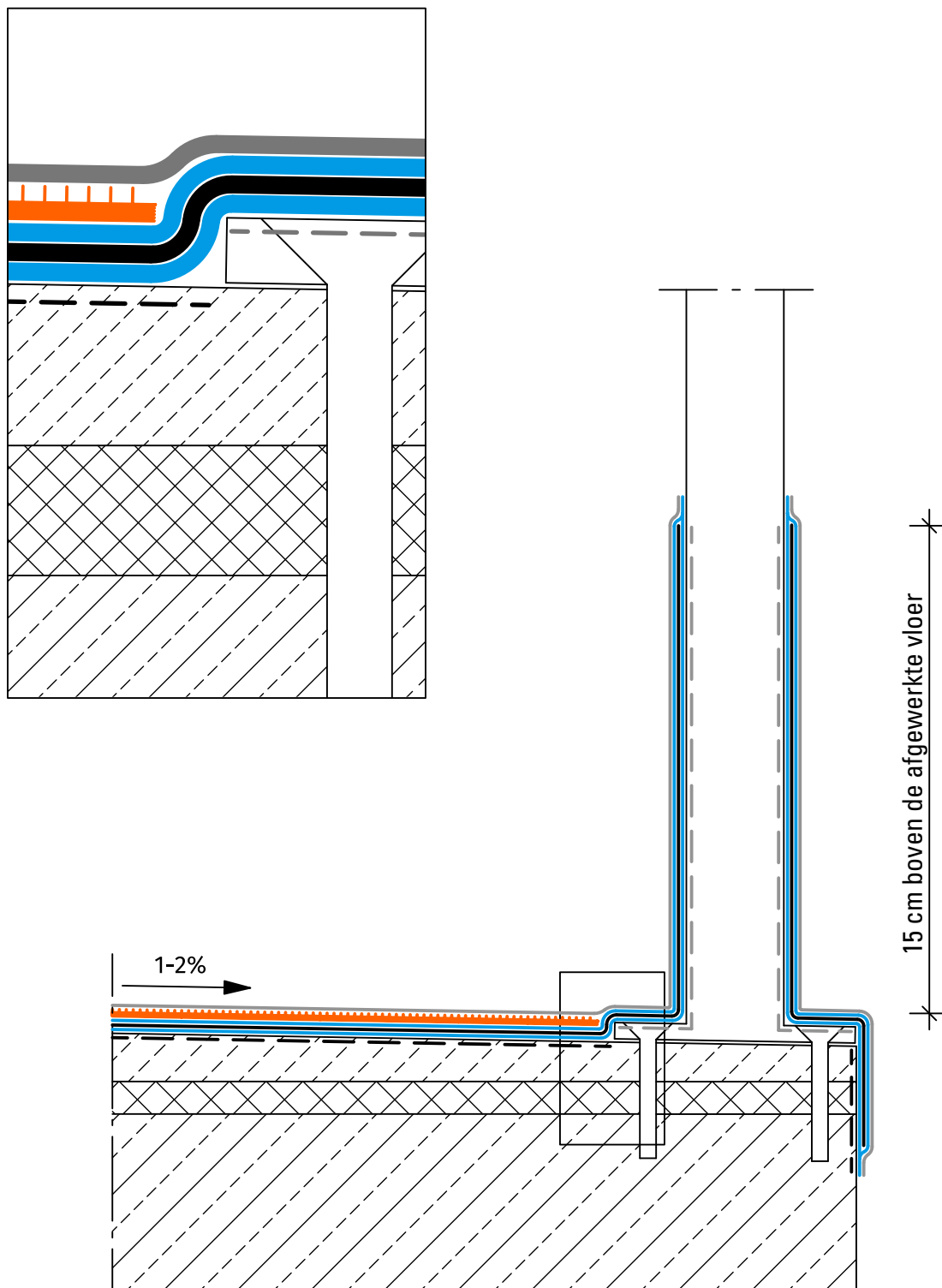

Legende:

-  Onderbouw
-  Drainageplaat
-  Aflopende dekvloer
-  Grondering I
-  Grondering II
-  Afdichtingslaag
-  Weefselvlies
-  Slijtlaag
-  Afdichting

Waterdicht detail 11a: Relingvoet

Grondering I	MC-DUR 1177 WV-A
Grondering II	afhankelijk van het materiaal (zie primerlijst)
Afdichtingslaag	MC-DUR TopSpeed flex plus
Elastisch afdichtmiddel	Mycoflex 488 MS
Slijtlaag	MC-DUR TopSpeed + Kwartszand
Afdichting	MC-DUR TopSpeed

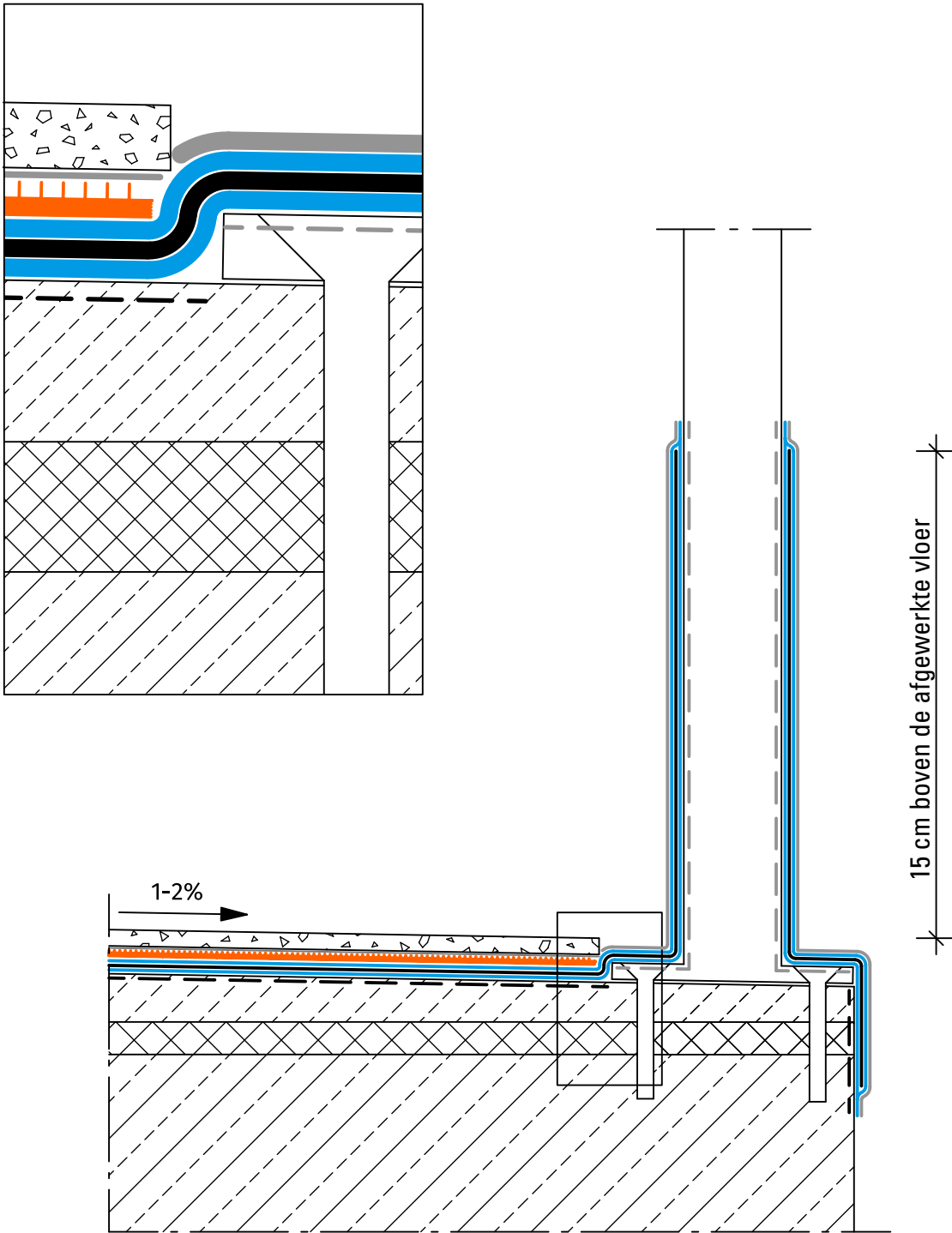

Legende:

- Onderbouw
- Aflopende dekvloer
- Drainageplaat
- Tegels
- Grondering I
- Grondering II
- Afdichtingslaag
- Weefselvlies
- Hechtlaag
- Tegellijm

Waterdicht detail 11b: Relingvoet met tegels

Grondering I	MC-DUR 1177 WV-A
Grondering II	afhankelijk van het materiaal (zie primerlijst)
Afdichtingslaag	MC-DUR TopSpeed flex plus
Weefselvlies	MC-Floor Tex
Hechtlaag	MC-DUR TopSpeed flex plus + Kwartzand
Tegellijm	afhankelijk van het materiaal

MC-DUR TopSpeed

Afdichtingssystemen voor balkons, galerijen, loggia's en daken

MC-Bouwchemie Nederland
Het Eek 9b
4004 LM Tiel
Tel. +31 344 633700
info@mc-bouwchemie.nl
www.mc-bauchemie.nl

MC-Bauchemie Belgium N.V.
Bedrijvenpark „La Corbeille“ Zone D
Conservenstraat 25
BE-2235 Westmeerbeek
Tel. +32 15 201462
info@mc-bauchemie.be
www.mc-bauchemie.com



BE SURE. BUILD SURE.

Contact gegevens
MC-Bouwchemie Nederland



Contact gegevens
MC-Bauchemie Belgium N.V.

